

Panasonic®

WMA MP3 CD Player/Receiver

Model: CQ-RX450W Installation Instructions



● Please read these instructions carefully before using this product and keep this manual for future reference.

Wiring

Caution To prevent damage to the unit, do not connect the power connector until the whole wiring is completed.

Fuse (15 A) Refer fuse replacement to your nearest authorized Panasonic Service Center. Do not try fuse replacement by yourself.

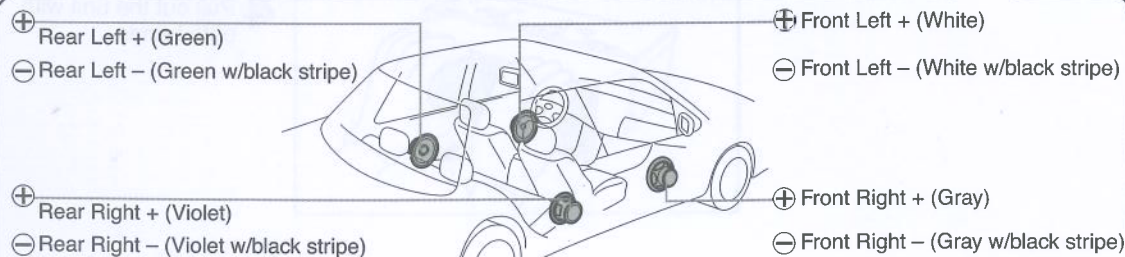
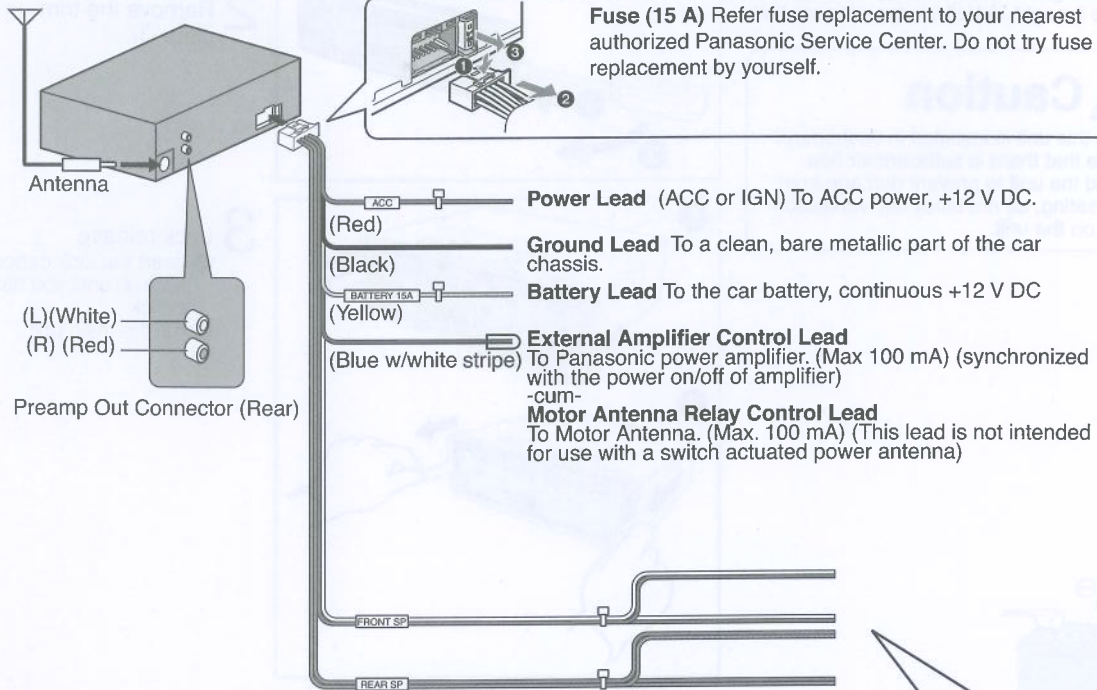

Before Installation

Consult a professional for installation.

- Verify the radio using the antenna and speakers before installation.
- Installation and mounting method vary with car manufacturers/car types. Please consult your nearest dealer or installer.

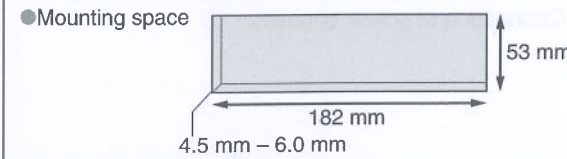
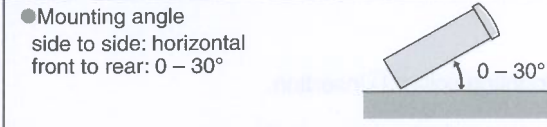

Remove Mounting Collar ① and Trim Plate ③ from the main unit temporarily, which are already mounted at shipment.

Before Wiring

Exclusively operated with 12 V battery with negative (-) ground.

Connect the power lead (red) very last.
Connect the battery lead (yellow) to the positive (+) terminal of the battery or fuse block terminal (BAT).
Strip about 5 mm of the lead ends for connection.

Apply insulating tape to bare leads.
Secure loosened leads.

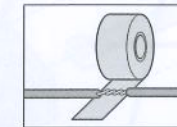

Speaker Connection

Connect as follows.

- Use ungrounded speakers only.
Allowable input : 50 W or more
Impedance : 4 - 8 Ω
- Use of speakers which do not match the specifications can cause burning, smoking or damage of the speakers.
- Distance between speaker and amplifier: 30 cm or more

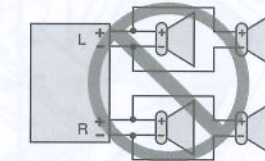
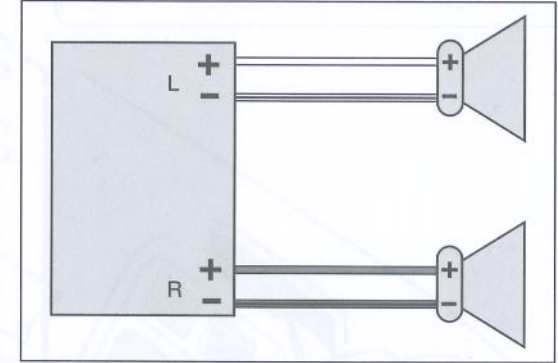

Caution

- Do not connect more than one speaker to one set of speaker leads. (except for connecting to a tweeter)
- Do not use a 3-wire type speaker system having a common earth lead.

Supplied Hardware

No.	Item	Diagram	Q'ty	No.	Item	Diagram	Q'ty
①	Mounting Collar (FX0214C384ZB)		1	④	Lock Cancel Plate		2
②	Power Connector (YGAJ021012)		1	⑤	Mounting Bolt (5 mm ø)		1
③	Trim Plate (YFC054C079YA)		1	⑥	Rubber Bushing		1

* ④, ⑤ and ⑥ consist of a set. (ZZBISC1101U-J)

Notes:

- The number in parentheses underneath each accessory part name is the part number for maintenance and service.
- Accessories and their part numbers are subject to modification without prior notice due to improvements.
- Mounting Collar and Trim Plate are mounted on the main unit at shipment.

Panasonic Corporation

Web Site : <http://panasonic.net>

Installation

How to install the unit

Caution

- Wear gloves for safety.
- Make sure that wiring is completed before installation.



1 Remove the cable from the battery negative terminal.

2 Mounting collar ① insertion.
Bend mounting tabs.

3 Connection of power connector ②

4 Main unit securing

4-2

Securing to the fire wall

Using the rubber bushing ⑥

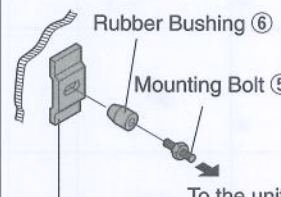

Rear Support Bracket (supplied with car)

Using the rear support strap (Option)

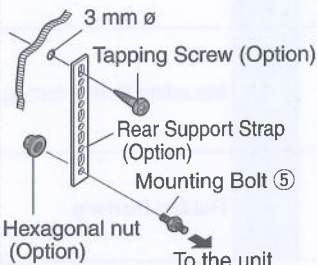

Hexagonal nut (Option)

4-1

4-3

4-2

Clank

Snapping point

5 Trim plate ③ mounting

6 Battery cable reconnection

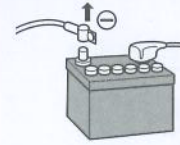

Bend appropriate tabs to secure the unit without backlash.

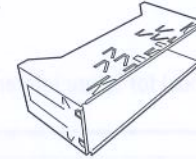

- 1 Screw the mounting bolt ⑤ into the main unit.
- 2 Securing to the fire wall
- 3 Snap the right and left springs into each hole.

Caution

When this unit is installed in dashboard, ensure that there is sufficient air flow around the unit to prevent damage from overheating, do not block any ventilation holes on the unit.

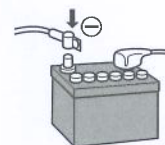

How to remove the unit

1 Remove the face plate.

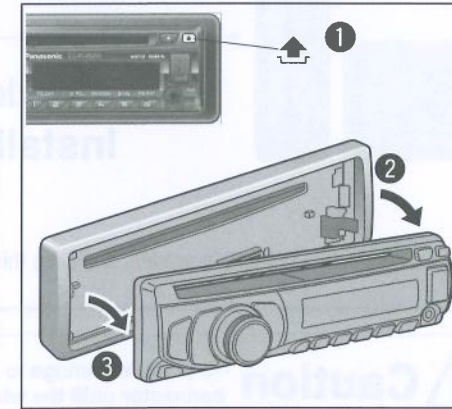

2 Remove the trim plate ③.

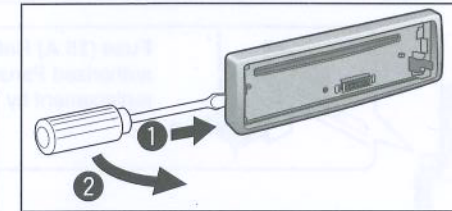

3 Lock release

- 1 Insert the lock cancel plate ④ until you hear a click.
- 2 Pull the main unit.

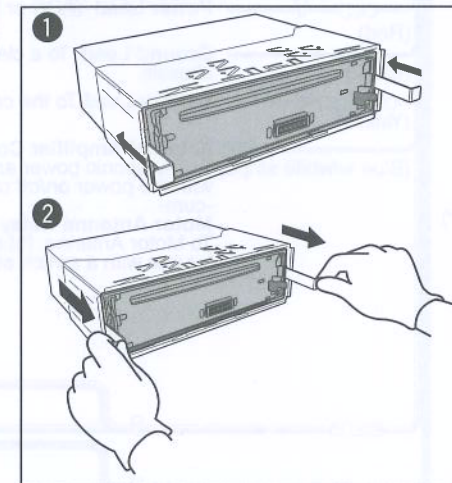

4 Pull out the unit with both hands.

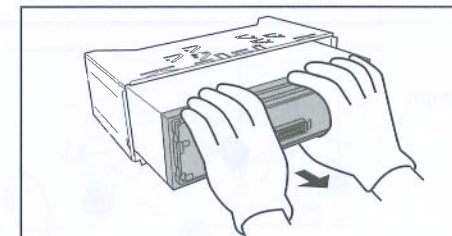

Final Installation

Lead Connections

Connect all wires, making sure that each connection is insulated and secure. Bundle all loose wires and fasten them with tape so they will not fall down later. Now insert the unit into the mounting collar.

Final Check

1. Make sure that all wires are properly connected and insulated.
2. Make sure that the main unit is securely held in the mounting collar.
3. Turn on the ignition to check the unit for proper operation.

If you have difficulties, consult your nearest authorized professional installer for assistance.