

Pioneer

CD RECEIVER

RADIO CD

CD PLAYER

CD接收機

جهاز استقبال مع مشغل اسطوانات CD

DEH-2250UBG

DEH-2250UB

English

Español

Português (B)

中文

العربية

Owner's Manual
Manual de instrucciones
Manual do proprietário
用戶手冊
كتيب المالك

SUPER TUNER III D

Before You Start

Thank you for purchasing this PIONEER product.

To ensure proper use, please read through this manual before using this product. It is especially important that you read and observe **WARNINGs** and **CAUTIONs** in this manual. *Please keep the manual in a safe and accessible place for future reference.* 

About this unit

CAUTION

- Do not allow this unit to come into contact with liquids. Electrical shock could result. Also, damage to this unit, smoke, and overheating could result from contact with liquids.
- “CLASS 1 LASER PRODUCT”
This product contains a laser diode of higher class than 1. To ensure continued safety, do not remove any covers or attempt to gain access to the inside of the product. Refer all servicing to qualified personnel.
- Always keep the volume low enough to hear outside sounds.
- Avoid exposure to moisture.
- If the battery is disconnected or discharged, any preset memory will be erased. 

In case of trouble

Should this unit fail to operate properly, please contact your dealer or nearest authorized PIONEER Service Station. 

Operating this unit

Head unit

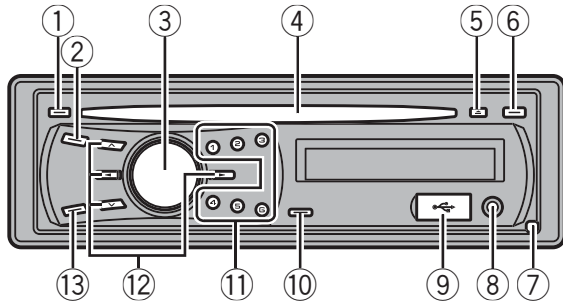

Part	Part
① DISP/↔/SCRL	⑧ AUX input jack (3.5 mm stereo jack)
② SRC/OFF	⑨ USB port
③ MULTI-CONTROL (M.C.)	⑩ 🔍 (list)
④ Disc loading slot	⑪ 1 to 6
⑤ ▲ (eject)	⑫ ▲/▼/◀/▶
⑥ CLOCK	⑬ BAND/ESC
⑦ Detach button	

⚠ CAUTION

Use an optional Pioneer USB cable (CD-U50E) to connect the USB audio player/USB memory to the USB port. Since the USB audio player/USB memory is projected forward from the unit, it is dangerous to connect directly. Do not use the unauthorized product. ■

Remote control

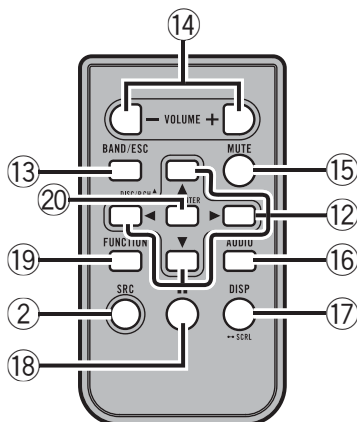

Part	Operation
⑭ VOLUME	Press to increase or decrease volume.
⑮ MUTE	Press to mute. Press again to unmute.
⑯ AUDIO	Press to select an audio function.
⑰ DISP/SCRL	Press to select different displays. Press and hold to scroll through the text information.
⑱ II	Press to pause or resume.
⑲ FUNCTION	Press to select functions. Press and hold to recall the initial setting menu when the sources are off.
⑳ LIST/ENTER	Press to display the disc title, track title, folder, or file list depending on the source. While in the operating menu, press to control functions.





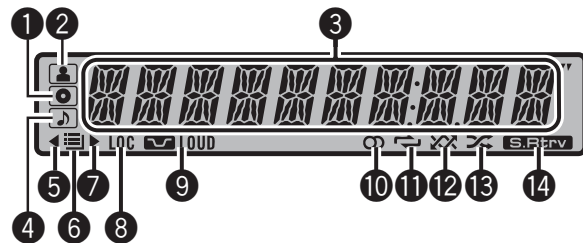







Display indication



Indicator	Operation
①	The disc (album) name is displayed. Album search refinement on the iPod browsing function is in use.
②	The disc (track) artist name is displayed. Artist search refinement on the iPod browsing function is in use.
③ Main display section	<ul style="list-style-type: none"> Tuner: band and frequency Built-in CD, USB and iPod: elapsed playback time and text information

Operating this unit

4	 (song)	The track (song) name is displayed. A playable audio file has been selected while operating the list. Song search refinement on the iPod browsing function is in use.
5		An upper tier of folder or menu exists.
6	 (folder)	The list function is operated.
7		A lower tier of folder or menu exists. It flashes when a song/album related to the song currently playing is selected from iPod.
8	LOC	The local seek tuning is on.
9	 LOUD (loudness)	The loudness is on.
10	 (stereo)	The selected frequency is being broadcasted in stereo.
11	 (repeat)	Track or folder repeat is on.
12	 (random)	Random play is on.
13	 (shuffle)	Shuffle function is on while the iPod source is being selected.
14	 (sound retriever)	The sound retriever function is on.



Basic Operations

Important

- Handle gently when removing or attaching the front panel.
- Avoid subjecting the front panel to excessive shock.
- Keep the front panel out of direct sunlight and high temperatures.
- Remove any cables and devices attached to this unit before detaching the front panel to avoid damage to the device or vehicle interior.

Removing the front panel to protect your unit from theft

- 1 Press the detach button to release the front panel.
- 2 Grab the front panel and remove.
- 3 Put the front panel into the provided protective case for safe keeping.

Re-attaching the front panel

- 1 Slide the front panel to the left until it clicks. Front panel and the head unit are connected on the left side. Make sure that the front panel has been properly connected to the head unit.

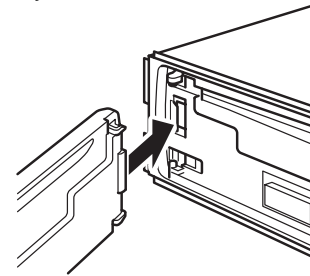

- 2 Press the right side of the front panel until it is firmly seated.
If you can't attach the front panel to the head unit successfully, try again. However, forcing the front panel into place may result in damage.

Turning the unit on

- 1 Press **SRC/OFF** to turn the unit on.

Turning the unit off

- 1 Press **SRC/OFF** and hold until the unit turns off.

Selecting a source

- 1 Press **SRC/OFF** to cycle between:
TUNER (tuner)—**CD** (built-in CD player)—**USB** (USB)/**IPOD** (iPod)—**AUX** (AUX)

Adjusting the volume

- 1 Turn **M.C.** to adjust volume.

Notes

- When this unit's blue/white lead is connected to the vehicle's auto-antenna relay control terminal, the vehicle's antenna extends when this unit's source is turned on. To retract the antenna, turn the source off.
- In this manual, iPod and iPhone will be referred to as iPod. 

Operating this unit

Use and care of the remote control

Using the remote control

- 1 Point the remote control in the direction of the front panel to operate.
When using for the first time, pull out the film protruding from the tray.

Replacing the battery

- 1 Slide the tray out on the back of the remote control.
- 2 Insert the battery with the plus (+) and minus (-) poles aligned properly.

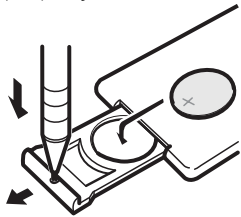

! WARNING

- Keep the battery out of the reach of children. Should the battery be swallowed, consult a doctor immediately.
- Batteries (battery pack or batteries installed) must not be exposed to excessive heat such as sunshine, fire or the like.

! CAUTION

- Use one **CR2025 (3 V)** lithium battery.
- Remove the battery if the remote control is not used for a month or longer.
- There is a danger of explosion if the battery is incorrectly replaced. Replace only with the same or equivalent type.
- Do not handle the battery with metallic tools.
- Do not store the battery with metallic objects.
- If the battery leaks, wipe the remote control completely clean and install a new battery.
- When disposing of used batteries, comply with governmental regulations or environmental public institutions' rules that apply in your country/area.

! Important

- Do not store the remote control in high temperatures or direct sunlight.
- The remote control may not function properly in direct sunlight.
- Do not let the remote control fall onto the floor, where it may become jammed under the brake or accelerator pedal. **■**

Menu operations identical for function settings/audio adjustments/initial settings/lists

Returning to the previous display

Returning to the previous list/category (the folder/category one level higher)

- 1 Press **DISP/↔/SCRL**.

Returning to the main menu

Returning to the top tier of list/category

- 1 Press and hold **DISP/↔/SCRL**.

Returning to the ordinary display

Canceling the initial setting menu

- 1 Press **BAND/ESC**.

Returning to the ordinary display from the list/category

- 1 Press **BAND/ESC**.



Tuner

! Important

If you are using this unit in North, Central or South America, reset the AM tuning step (refer to **AM STEP** (*AM tuning step*) on page 11).

Basic Operations

Selecting a band

- 1 Press **BAND/ESC** until the desired band (**F1**, **F2**, **F3** for FM or **AM**) is displayed.

Manual tuning (step by step)

- 1 Press ◀ or ▶.

Seeking

- 1 Press and hold ◀ or ▶, and then release. You can cancel seek tuning by briefly pressing ◀ or ▶. While pressing and holding ◀ or ▶, you can skip stations. Seek tuning starts as soon as you release ◀ or ▶.

Storing and recalling stations

You can easily store up to six stations for each band as presets.

- **When you find a station that you want to store in memory, press one of the preset tuning buttons (1 to 6) and hold until the preset number stops flashing.**

Stored radio station frequency can be recalled by pressing the preset tuning button.

- You can also recall stored radio stations by pressing ▲ or ▼ during the frequency display.

Function settings

1 Press M.C. to display the main menu.

2 Turn M.C. to change the menu option and press to select FUNCTION.

3 Turn M.C. to select the function.

After selecting, perform the following procedures to set the function.

BSM (best stations memory)

BSM (best stations memory) automatically stores the six strongest stations in the order of their signal strength.

- 1 Press **M.C.** to turn BSM on. To cancel, press **M.C.** again.

LOCAL (local seek tuning)

Local seek tuning lets you tune in only those radio stations with sufficiently strong signals for good reception.

- 1 Press **M.C.** to display the setting mode.
- 2 Turn **M.C.** to select the desired setting.
FM: **OFF—LEVEL 1—LEVEL 2—LEVEL 3—LEVEL 4**
AM: **OFF—LEVEL 1—LEVEL 2**
Larger setting number is higher level. The highest level setting allows reception of only the strongest stations, while lower settings let you receive progressively weaker stations.
- 3 Press **M.C.** to confirm the selection.



Note

Operation is complete even if the menu is cancelled before being confirmed. ■

CD/CD-R/CD-RW and USB storage devices

Basic Operations

Playing a CD/CD-R/CD-RW

- 1 Insert the disc, label side up, into the disc loading slot.
- 1 If a disc has already been inserted, press **SRC/OFF** to select the built-in CD player.

Ejecting a CD/CD-R/CD-RW

- 1 Press ▲.

Playing songs on a USB storage device

- 1 Open the USB connector cover and plug in the USB storage device using a USB cable.

Stop playing a USB storage device

- 1 You may disconnect the USB storage device at anytime.

Selecting a folder

- 1 Press ▲ or ▼.

Selecting a track

- 1 Press ◀ or ▶.

Fast forwarding or reversing

- 1 Press and hold ◀ or ▶.

Operating this unit

Returning to root folder

- 1 Press and hold **BAND/ESC**.

Switching between compressed audio and CD-DA

- 1 Press **BAND/ESC**.

Notes

- When playing compressed audio, there is no sound during fast forward or reverse.
- USB portable audio players that can be charged via USB will be recharged when plugged in and the ignition switch is set to ACC or ON.
- Disconnect USB storage device from unit when not in use.
- If plug and play is on and a USB storage device is present, depending on the type of device, the source may switch to **USB** automatically when you turn on the engine. Please change plug and play setting as necessary. Refer to **USB (plug and play)** on page 12.

Displaying text information

Selecting the desired text information

- 1 Press **DISP/↔/SCRL**.

CD TEXT discs: Play time—disc title—disc artist name—track title—track artist name

WMA/MP3: Play time—folder name—file name—track title—artist name—album title—comment—bit rate—folder and track numbers

WAV: Play time—folder name—file name—sampling frequency—folder and track numbers

Scrolling the text information to the left

- 1 Press and hold **DISP/↔/SCRL**.

Notes

- Incompatible text stored with the audio file may not be displayed or may be displayed incorrectly.
- Depending on the version of iTunes used to write MP3 files onto a disc, comment information may be incorrectly displayed.
- When playing back VBR (variable bit rate)-recorded WMA files, the average bit rate value is displayed.

- When playing back VBR (variable bit rate)-recorded MP3 files, **VBR** is displayed instead of bit rate value.

Selecting and playing files/tracks from the name list

1 Press **Q** to switch to the file/track name list mode.

2 Use **M.C.** to select the desired file name (or folder name).

Changing file or folder name

- 1 Turn **M.C.**

Playing

- 1 When a file or track is selected, press **M.C.**

Seeing a list of files (or folders) in the selected folder

- 1 When a folder is selected, press **M.C.**

Playing a song in the selected folder

- 1 When a folder is selected, press and hold **M.C.**

Note

Track title list will display the list of track titles on a CD TEXT disc.

Advanced operations using special buttons

Selecting a repeat play range

- 1 Press **6/↔** to cycle between the following:

CD/CD-R/CD-RW

- **DISC** – Repeat all tracks
- **TRACK** – Repeat the current track
- **FOLDER** – Repeat the current folder

USB audio player/USB memory

- **TRACK** – Repeat the current file
- **FOLDER** – Repeat the current folder
- **ALL** – Repeat all files

Playing tracks in random order

- 1 Press **5/⌘** to turn random play on or off. Tracks in a selected repeat range are played in random order.

Pausing playback

- 1 Press **2/PAUSE** to pause or resume.

Enhancing compressed audio and restoring rich sound (sound retriever)

- 1 Press **1/S.Rtrv** to cycle between:
OFF (off)—**1—2**
1 is effective for low compression rates, and **2** is effective for high compression rates.

Function settings

1 Press M.C. to display the main menu.

2 Turn M.C. to change the menu option and press to select FUNCTION.

3 Turn M.C. to select the function.

After selecting, perform the following procedures to set the function.

REPEAT (repeat play)

- 1 Press **M.C.** to display the setting mode.
- 2 Turn **M.C.** to select a repeat play range.
For details, refer to *Selecting a repeat play range* on the previous page.
- 3 Press **M.C.** to confirm the selection.

RANDOM (random play)

- 1 Press **M.C.** to turn random play on or off.

PAUSE (pause)

- 1 Press **M.C.** to pause or resume.

S.RTRV (sound retriever)

Automatically enhances compressed audio and restores rich sound.

- 1 Press **M.C.** to display the setting mode.
- 2 Turn **M.C.** to select the desired setting.
For details, refer to *Enhancing compressed audio and restoring rich sound (sound retriever)* on this page.
- 3 Press **M.C.** to confirm the selection.



Note

Operation is complete even if the menu is cancelled before being confirmed. ■

iPod

Basic Operations

Playing songs on iPod

- 1 Open the USB connector cover and plug in an iPod using the iPod Dock Connector to USB Cable.

Selecting a track (chapter)

- 1 Press ◀ or ▶.

Fast forwarding or reversing

- 1 Press and hold ◀ or ▶.



Notes

- The iPod's battery will be charged if the ignition switch is set to ACC or ON, while connected.
- While the iPod is connected to this unit, the iPod cannot be turned on or off unless the control mode is set to **IPOD**.
- Disconnect headphones from the iPod before connecting to this unit.
- The iPod will turn off about two minutes after the ignition switch is set to OFF.

Displaying text information

Selecting the desired text information

- 1 Press **DISP/↔/SCRL**.
Play time—song title—artist name—album title
—number of songs

Scrolling the text information to the left

- 1 Press and hold **DISP/↔/SCRL**.



Note

Incompatible text saved on the iPod will not be displayed by the unit.

Browsing for a song

1 Press 🔍 to switch to the top menu of the list search.

Operating this unit

2 Use M.C. to select a category/song.

Changing the name of song or category <ol style="list-style-type: none"> 1 Turn M.C. PLAYLISTS (playlists)—ARTISTS (artists)—ALBUMS (albums)—SONGS (songs)—PODCASTS (podcasts)—GENRES (genres)—COMPOSERS (composers)—AUDIOBOOKS (audiobooks)
Playing <ol style="list-style-type: none"> 1 When a song is selected, press M.C.
Seeing a list of songs in the selected category <ol style="list-style-type: none"> 1 When a category is selected, press M.C.
Playing a song in the selected category <ol style="list-style-type: none"> 1 When a category is selected, press and hold M.C.
Searching by alphabet in the list <ol style="list-style-type: none"> 1 When a list for the selected category is displayed, press Q to switch to alphabet search mode. 2 Turn M.C. to select a letter. 3 Press M.C. to display the alphabetical list. If alphabet search is aborted, NOT FOUND is displayed.



Note

Depending on the number of files in the iPod, there may be a delay when displaying a list.

Advanced operations using special buttons

Selecting a repeat play range <ol style="list-style-type: none"> 1 Press 6/↺ to cycle between the following: <ul style="list-style-type: none"> • ONE – Repeat the current song • ALL – Repeat all songs in the selected list
Playing all songs in a random order (shuffle all) <ol style="list-style-type: none"> 1 Press 5/↻ to turn shuffle all on.
Pausing playback Refer to <i>Pausing playback</i> on the previous page.

Playing songs related to the currently playing song
You can play songs from the following lists.

- Album list of currently playing artist
- Song list of currently playing album
- Album list of currently playing genre

- 1 Press and hold **M.C.** to switch to the link play mode.

- 2 Turn **M.C.** to change the mode; press to select.

- **ARTIST** – Plays an album of currently playing artist.
- **ALBUM** – Plays a song of currently playing album.
- **GENRE** – Plays an album of currently playing genre.

The selected song/album will be played after the currently playing song.

The selected song/album may be cancelled if you operate functions other than link search (e.g. fast forward and reverse).

If no related albums/songs are found, **NOT FOUND** is displayed.

Depending on the song selected to play, the end of the currently playing song and the beginning of the selected song/album may be cut off.

Operating this unit's iPod function from your iPod
This function is not compatible with the following iPod models.

- iPod nano 1st generation
- iPod 5th generation

This unit's iPod function allows you to conduct operations from your iPod and listen to it using your car's speakers.

- 1 Press **4/IPOD** to switch the control mode.

- **IPOD** – This unit's iPod function can be operated from the connected iPod.
- **AUDIO** – This unit's iPod function can be operated from this unit.

Enhancing compressed audio and restoring rich sound (sound retriever)

Refer to *Enhancing compressed audio and restoring rich sound (sound retriever)* on the previous page.

Function settings

1 Press M.C. to display the main menu.

2 Turn M.C. to change the menu option and press to select FUNCTION.

3 Turn M.C. to select the function.

After selecting, perform the following procedures to set the function.

REPEAT (repeat play)

- Refer to **REPEAT** (*repeat play*) on page 8. However the repeat range is different from CD/USB storage device. Refer to *Selecting a repeat play range* on the previous page.

SHUFFLE (shuffle)

- 1 Press **M.C.** to display the setting mode.
- 2 Turn **M.C.** to select your favorite setting.
 - **SONGS** – Play back songs in the selected list in random order.
 - **ALBUMS** – Play back songs from a randomly selected album in order.
 - **OFF** – Cancel random play.
- 3 Press **M.C.** to confirm the selection.

SHUFFLE ALL (shuffle all)

- 1 Press **M.C.** to turn shuffle all on. To turn off, set **SHUFFLE** in the **FUNCTION** menu to off.

LINK PLAY (link play)

- 1 Press **M.C.** to display the setting mode.
- 2 Turn **M.C.** to change the mode; press to select. For details about the settings, refer to *Playing songs related to the currently playing song* on the previous page.

CTRL (control mode)

- 1 Press **M.C.** to select your favorite setting. For details about the settings, refer to *Operating this unit's iPod function from your iPod* on the previous page.

PAUSE (pause)

- Refer to **PAUSE** (*pause*) on page 8.

AUDIO BOOK (audiobook speed)

The playback speed of audiobook can be changed.

- 1 Press **M.C.** to display the setting mode.
- 2 Turn **M.C.** to select your favorite setting.
 - **FASTER** – Playback faster than normal speed
 - **NORMAL** – Playback in normal speed
 - **SLOWER** – Playback slower than normal speed
- 3 Press **M.C.** to confirm the selection.

S.RTRV (sound retriever)

- Refer to **S.RTRV** (*sound retriever*) on page 8.

**Notes**

- Operation is complete even if the menu is cancelled before being confirmed.
- Switching the control mode to **IPOD** pauses song playback. Operate the iPod to resume playback.
- The following functions are still accessible from the unit even if the control mode is set to **IPOD**.
 - Volume
 - Fast forward/reverse
 - Track up/down
 - Pausing
 - Switching the text information
- When the control mode is set to **IPOD**, operations are limited as follows:
 - Only **CTRL** (control mode), **PAUSE** (pause) and **S.RTRV** (sound retriever) functions are available.
 - Browse function cannot be operated from this unit.

Audio Adjustments**1 Press M.C. to display the main menu.****2 Turn M.C. to change the menu option and press to select AUDIO.****3 Turn M.C. to select the audio function.**

After selecting, perform the following procedures to set the audio function.

FAD/BAL (fader/balance adjustment)

You can change the fader/balance setting.

- 1 Press **M.C.** to display the setting mode.
- 2 Press **M.C.** to cycle between fader and balance.
- 3 Turn **M.C.** to adjust speaker balance.
 - Adjustment range (front/rear): **F15** to **R15**
 - Adjustment range (left/right): **L15** to **R15**
 - FR 0** is the proper setting when only two speakers are used.

EQUALIZER (equalizer recall)

Operating this unit

There are six stored settings **DYNAMIC** (dynamic), **VOCAL** (vocal), **NATURAL** (natural), **CUSTOM** (custom), **FLAT** (flat) and **POWERFUL** (powerful).

- When **FLAT** is selected no adjustments are made to the sound.
- Press **M.C.** to display the setting mode.
 - Turn **M.C.** to select the equalizer.
DYNAMIC—VOCAL—NATURAL—CUSTOM—FLAT—POWERFUL
 - Press **M.C.** to confirm the selection.

TONE CTRL (equalizer adjustment)

You can adjust the bass/mid/treble level.

- Adjusted equalizer curve settings are stored in **CUSTOM**.
- Press **M.C.** to display the setting mode.
 - Press **M.C.** to select **BASS** (bass)/**MID** (mid)/**TREBLE** (treble).
 - Turn **M.C.** to adjust the level.
Adjustment range: **+6** to **-6**

LOUDNESS (loudness)

Loudness compensates for deficiencies in the low- and high-frequency ranges at low volume.

- Press **M.C.** to display the setting mode.
- Turn **M.C.** to select the desired setting.
OFF (off)—**LOW** (low)—**HIGH** (high)
- Press **M.C.** to confirm the selection.

SLA (source level adjustment)

SLA (Source level adjustment) lets you adjust the volume level of each source to prevent radical changes in volume when switching between sources.

- Settings are based on the FM volume level, which remains unchanged.
Before adjusting source levels, compare the FM volume level with the level of the source you wish to adjust.
 - The AM volume level can also be adjusted with source level adjustments.
- Press **M.C.** to display the setting mode.
 - Turn **M.C.** to adjust the source volume.
Adjustment range: **+4** to **-4**
 - Press **M.C.** to confirm the selection.

Notes

- When selecting FM as the source, you cannot switch to **SLA**.
- Operation is complete even if the menu is cancelled before being confirmed. 

Initial Settings

1 Press SRC/OFF and hold until the unit turns off.

2 Press M.C. and hold until CLOCK SET appears in the display.

3 Turn M.C. to select the initial setting.
After selecting, perform the following procedures to set the initial setting.

CLOCK SET (setting the clock)

- Press **M.C.** to display the setting mode.
- Press **M.C.** to select the segment of the clock display you wish to set.
Hour—Minute
As you select segments of the clock display, the selected segment flashes.
- Turn **M.C.** to adjust the clock.

FM STEP (FM tuning step)

The FM tuning step employed by seek tuning can be switched between 100 kHz, the preset step, and 50 kHz.

- If seek tuning is performed in 50 kHz steps, stations may be tuned in imprecisely. Tune in the stations with manual tuning or use seek tuning again.
 - The tuning step remains at 50 kHz during manual tuning.
- Press **M.C.** to display the setting mode.
 - Turn **M.C.** to select the FM tuning step.
50 KHZ (50 kHz)—**100 KHZ** (100 kHz)
 - Press **M.C.** to confirm the selection.

AM STEP (AM tuning step)

The AM tuning step can be switched between 9 kHz, the preset step, and 10 kHz. When using the tuner in North, Central or South America, reset the tuning step from 9 kHz (531 kHz to 1 602 kHz allowable) to 10 kHz (530 kHz to 1 640 kHz allowable).

- Press **M.C.** to display the setting mode.
- Turn **M.C.** to select the AM tuning step.
10 KHZ (10 kHz)—**9 KHZ** (9 kHz)
- Press **M.C.** to confirm the selection.

AUX (auxiliary input)

Activate this setting when using auxiliary device connected to this unit.

- Press **M.C.** to turn **AUX** on or off.

USB (plug and play)

This setting allows you to switch your source to **USB/IPOD** automatically.

- 1 Press **M.C.** to turn the plug and play on or off.
ON – When USB storage device/iPod is connected, the source is automatically switched to **USB/IPOD**. If you disconnect your USB storage device/iPod, this unit's source is turned off.
OFF – When USB storage device/iPod is connected, the source is not switched to **USB/IPOD** automatically. Please change the source to **USB/IPOD** manually.

**Note**

Operation is complete even if the menu is cancelled before being confirmed.

Using the AUX source

- 1 Insert the stereo mini plug into the AUX input jack.
- 2 Press **SRC/OFF** to select **AUX** as the source.

**Note**

AUX cannot be selected unless the auxiliary setting is turned on. For more details, refer to **AUX** (*auxiliary input*) on the previous page.

Turning the clock display on or off

- Press **CLOCK** to turn the clock display on or off.

**Note**

The clock display disappears temporarily when you perform other operations, but the clock display appears again after 25 seconds.

Connections

! WARNING

- Use speakers over 50 W (output value) and between 4 Ω to 8 Ω (impedance value). Do not use 1 Ω to 3 Ω speakers for this unit.
- The black cable is ground. When installing this unit or power amp (sold separately), make sure to connect the ground wire first. Ensure that the ground wire is properly connected to metal parts of the car's body. The ground wire of the power amp and the one of this unit or any other device must be connected to the car separately with different screws. If the screw for the ground wire loosens or falls out, it could result in fire, generation of smoke or malfunction.

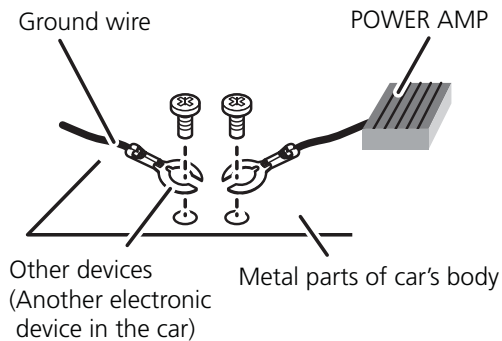

📌 Important

- When installing this unit in a vehicle without an ACC (accessory) position on the ignition switch, failure to connect the red cable to the terminal that detects operation of the ignition key may result in battery drain.



ACC position



No ACC position

- Use this unit with a 12-volt battery and negative grounding only. Failure to do so may result in a fire or malfunction.
- To prevent a short-circuit, overheating or malfunction, be sure to follow the directions below.
 - Disconnect the negative terminal of the battery before installation.

- Secure the wiring with cable clamps or adhesive tape. Wrap adhesive tape around wiring that comes into contact with metal parts to protect the wiring.
- Place all cables away from moving parts, such as the gear shift and seat rails.
- Place all cables away from hot places, such as near the heater outlet.
- Do not connect the yellow cable to the battery by passing it through the hole to the engine compartment.
- Cover any disconnected cable connectors with insulating tape.
- Do not shorten any cables.
- Never cut the insulation of the power cable of this unit in order to share the power with other devices. The current capacity of the cable is limited.
- Use a fuse of the rating prescribed.
- Never wire the negative speaker cable directly to ground.
- Never band together negative cables of multiple speakers.
- When this unit is on, control signals are sent through the blue/white cable. Connect this cable to the system remote control of an external power amp or the vehicle's auto-antenna relay control terminal (max. 300 mA 12 V DC). If the vehicle is equipped with a glass antenna, connect it to the antenna booster power supply terminal.
- Never connect the blue/white cable to the power terminal of an external power amp. Also, never connect it to the power terminal of the auto antenna. Doing so may result in battery drain or a malfunction.

Connection diagram

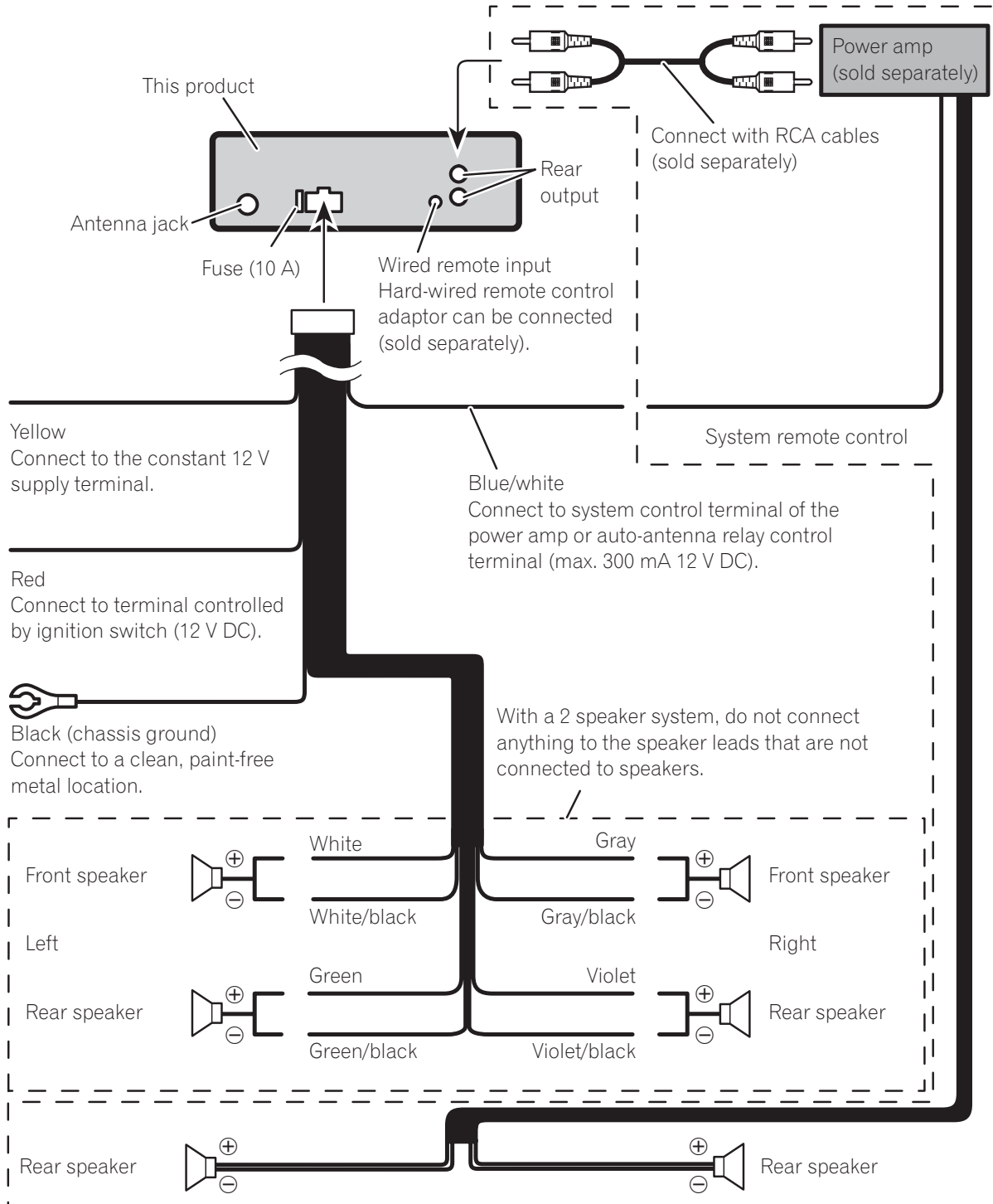

Perform these connections when using the optional amplifier.



Installation

Important

- Check all connections and systems before final installation.
- Do not use unauthorized parts as this may cause malfunctions.
- Consult your dealer if installation requires drilling of holes or other modifications to the vehicle.
- Do not install this unit where :
 - it may interfere with operation of the vehicle.
 - it may cause injury to a passenger as a result of a sudden stop.
- The semiconductor laser will be damaged if it overheats. Install this unit away from hot places such as near the heater outlet.
- Optimum performance is obtained when the unit is installed at an angle of less than 60°.

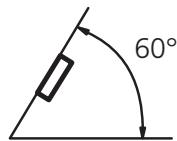

- To ensure proper heat dispersal when using this unit, make sure you leave ample space behind the rear panel and wrap any loose cables so they are not blocking the vents when installing the unit.

DIN front/rear mount

This unit can be properly installed either from “Front” (conventional DIN front-mount) or “Rear” (DIN rear-mount installation, utilizing threaded screw holes on the sides of unit chassis). For details, refer to the following installation methods.

DIN Front-mount

1 Insert the mounting sleeve into the dashboard.

For installation in shallow spaces, use the supplied mounting sleeve. If there is enough

space, use the mounting sleeve that came with the vehicle.

2 Secure the mounting sleeve by using a screwdriver to bend the metal tabs (90°) into place.

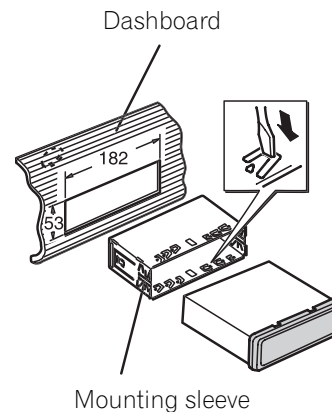

3 Install the unit as illustrated.

Use commercially available parts when installing.

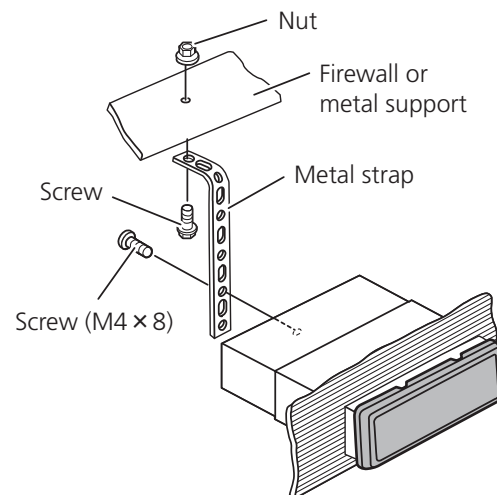

- Make sure that the unit is installed securely in place. An unstable installation may cause skipping or other malfunctions.

DIN Rear-mount

1 Determine the appropriate position where the holes on the bracket and the side of the unit match.

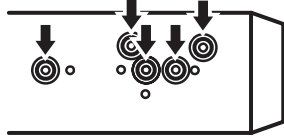

2 Tighten two screws on each side.

Truss screw (5 mm × 8 mm)

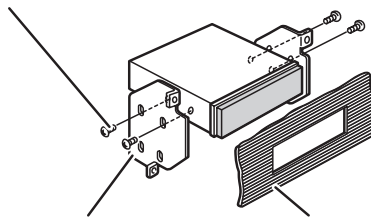

Mounting bracket

Dashboard or console

3 Pull the unit out of the dashboard.

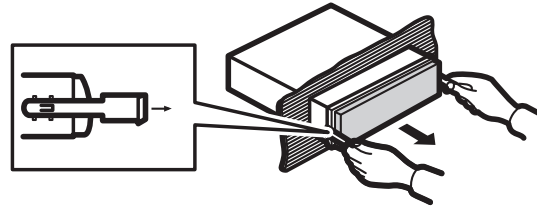

Removing the unit

1 Extend top and bottom of the trim ring outwards to remove the trim ring. (When reattaching the trim ring, point the side with the groove down.)

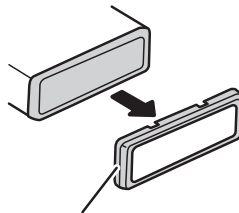

Trim ring

- Releasing the front panel allows easier access to the trim ring.

2 Insert the supplied extraction keys into both sides of the unit until they click into place.

Additional Information

Troubleshooting

Symptom	Cause	Action
The display automatically returns to the ordinary display.	You did not perform any operation within about 30 seconds.	Perform operation again.
The repeat play range changes unexpectedly.	Depending on the repeat play range, the selected range may change when selecting another folder or track, or when fast forwarding/reversing.	Select the repeat play range again.
A subfolder is not played back.	Subfolders cannot be played when FOLDER (folder repeat) is selected.	Select another repeat play range.
NO XXXX appears when a display is changed (e.g., NO TITLE).	No text information embedded	Switch the display or play another track/file.
The unit is malfunctioning. There is interference.	You are using a device, such as a cell phone, that transmits electromagnetic waves near the unit.	Move electrical devices that may be causing the interference away from the unit.



Error messages

When you contact your dealer or your nearest Pioneer Service Center, be sure to note the error message.

Built-in CD Player

Message	Cause	Action
ERROR-11, 12, 17, 30	Dirty disc	Clean disc.
	Scratched disc	Replace disc.

ERROR-10, 11, 12, 15, 17, 30, A0	Electrical or mechanical	Turn the ignition switch OFF and back ON, or switch to a different source, then back to the CD player.
ERROR-15	The inserted disc is blank	Replace disc.
ERROR-22, 23	Unsupported CD format	Replace disc.
FRMT READ	There is sometimes a delay between the start of playback and when you start to hear any sound	Wait until the message disappears and you hear sound.
NO AUDIO	The inserted disc does not contain any playable files	Replace disc.
SKIPPED	The inserted disc contains DRM protected WMA files	Replace disc.
PROTECT	All the files on the inserted disc are embedded with DRM	Replace disc.

USB storage device

Message	Cause	Action
NO DEVICE	When plug and play is off, no USB storage device is connected.	<ul style="list-style-type: none"> Turn the plug and play on. Connect a compatible USB storage device.
FRMT READ	There is sometimes a delay between the start of playback and when you start to hear any sound	Wait until the message disappears and you hear sound.
NO AUDIO	No songs	Transfer the audio files to the USB storage device and connect.
	The connected USB storage device has security enabled	Follow the USB storage device instructions to disable the security.

Additional Information

SKIPPED	The connected USB storage device contains WMA files embedded with Windows Media™ DRM 9/10	Play an audio file not embedded with Windows Media DRM 9/10.
PROTECT	All the files in the USB storage device are embedded with Windows Media DRM 9/10	Transfer audio files not embedded with Windows Media DRM 9/10 to the USB storage device and connect.
N/A USB	The USB storage device connected to is not supported by this unit.	Connect a USB Mass Storage Class compliant device.
CHECK USB	The USB connector or USB cable has short-circuited.	Check that the USB connector or USB cable is not caught in something or damaged.
	The connected USB storage device consumes more than 500 mA (maximum allowable current).	Disconnect the USB storage device and do not use it. Turn the ignition switch to OFF, then to ACC or ON and then connect only compliant USB storage devices.
ERROR-18	Not compatible USB device	Disconnect your device and replace it with a compatible USB storage device.
ERROR-19	Communication failure	Perform one of the following operations. –Turn the ignition switch OFF and back ON. –Disconnect or eject the USB storage device. –Change to a different source. Then, return to the USB source.

ERROR-23	USB storage device is not formatted with FAT16 or FAT32	USB storage device should be formatted with FAT16 or FAT32.
-----------------	---	---

iPod

Message	Cause	Action
NO DEVICE	When plug and play is off, no USB storage device or iPod is connected.	<ul style="list-style-type: none"> • Turn the plug and play on. • Connect a compatible iPod.
FRMT READ	There is sometimes a delay between the start of playback and when you start to hear any sound	Wait until the message disappears and you hear sound.
ERROR-19	Communication failure	Disconnect the cable from iPod. Once iPod's main menu is displayed, reconnect cable. Reset the iPod.
	iPod failure	Disconnect the cable from iPod. Once iPod's main menu is displayed, reconnect cable. Reset the iPod.
ERROR-16, 18	Old iPod firmware versions	Update the iPod version.
	iPod failure	Disconnect the cable from iPod. Once iPod's main menu is displayed, reconnect cable. Reset the iPod.
CHECK USB	iPod operates correctly but does not charge	Check if the connection cable for iPod shorted out (e.g., not caught in metal objects). After checking, turn the ignition switch OFF and back ON or disconnect the iPod and reconnect.
NO SONGS	No songs	Transfer songs to iPod.

Additional Information

STOP

No songs in the current list Select a list that contains songs.



Handling guideline

Discs and player

Use only discs featuring either of following two logos.



Use 12-cm disc. Do not use 8-cm disc or an adapter for 8-cm disc.

Use only conventional, fully circular discs. Do not use shaped discs.



Do not insert anything other than a CD into the CD loading slot.

Do not use cracked, chipped, warped, or otherwise damaged discs as they may damage the player.

Unfinalized CD-R/CD-RW disc playback is not possible.

Do not touch the recorded surface of the discs.

Store discs in their cases when not in use.

Avoid leaving discs in excessively hot environments including under direct sunlight.

Do not attach labels, write on or apply chemicals to the surface of the discs.

To clean a CD, wipe the disc with a soft cloth outward from the center.

Condensation may temporarily impair the player's performance. Leave it to adjust to the warmer temperature for about one hour. Also, wipe any damp discs with a soft cloth.

Playback of discs may not be possible because of disc characteristics, disc format, recorded application, playback environment, storage conditions, and so on.

Road shocks may interrupt disc playback.

Read the precautions for discs before using them.

USB storage device

Address any questions you have about your USB storage device to the manufacturer of the device.

Connections via a USB hub are not supported.

Do not connect anything other than a USB storage device.

Do not leave the USB storage device in any place with high temperatures.

Firmly secure the USB storage device when driving. Do not let the USB storage device fall onto the floor, where it may become jammed under the brake or accelerator pedal.

Depending on the USB storage device, the following problems may occur.

- Operations may vary.
- This unit may not recognize the storage device.
- The file may not be played back properly.
- The device may generate noise in the radio.

iPod

Do not leave the iPod in direct sunlight for extended amounts of time. Extended exposure to direct sunlight can result in iPod malfunction due to the resulting high temperature.

Do not leave the iPod in any place with high temperatures.

To ensure proper operation, connect the dock connector cable from the iPod directly to this unit.

Firmly secure the iPod when driving. Do not let the iPod fall onto the floor, where it may become jammed under the brake or accelerator pedal.

Additional Information

For details, refer to the iPod's manuals.

About iPod settings

- You cannot operate the iPod Equalizer on Pioneer products. We recommend that you set the iPod Equalizer to off, before connecting to this unit.
- You cannot set Repeat to off on the iPod when using this unit. Repeat is automatically changed to All when connecting the iPod to this unit.

DualDiscs

DualDiscs are two-sided discs that have a recordable CD for audio on one side and a recordable DVD for video on the other.

Since the CD side of DualDiscs is not physically compatible with the general CD standard, it may not be possible to play the CD side with this unit.

Frequent loading and ejecting of a DualDisc may result in scratches on the disc. Serious scratches can lead to playback problems on this unit. In some cases, a DualDisc may become stuck in the disc loading slot and will not eject. To prevent this, we recommend you refrain from using DualDisc with this unit. Please refer to the information from the disc manufacturer for more detailed information about DualDiscs.



Compressed audio compatibility (disc, USB)

WMA

File extension: .wma

Bit rate: 48 kbps to 320 kbps (CBR), 48 kbps to 384 kbps (VBR)

Sampling frequency: 32 kHz, 44.1 kHz, 48 kHz

Windows Media Audio Professional, Lossless, Voice/DRM Stream/Stream with video: No

MP3

File extension: .mp3

Bit rate: 8 kbps to 320 kbps

Sampling frequency: 16 kHz to 48 kHz (32, 44.1, 48 kHz for emphasis)

Compatible ID3 tag version: 1.0, 1.1, 2.2, 2.3, 2.4 (ID3 tag Version 2.x is given priority over Version 1.x.)

M3u playlist: No

MP3i (MP3 interactive), mp3 PRO: No

WAV

File extension: .wav

Quantization bits: 8 and 16 (LPCM), 4 (MS ADPCM)

Sampling frequency: 16 kHz to 48 kHz (LPCM), 22.05 kHz and 44.1 kHz (MS ADPCM)

Supplemental information

Only the first 32 characters can be displayed as a file name (including the file extension) or a folder name.

This unit may not operate correctly depending on the application used to encode WMA files.

There may be a slight delay when starting playback of audio files embedded with image data.

Disc

Playable folder hierarchy: up to eight tiers (A practical hierarchy is less than two tiers.)

Playable folders: up to 99

Playable files: up to 999

File system: ISO 9660 Level 1 and 2, Romeo, Joliet

Multi-session playback: Yes

Packet write data transfer: No

Regardless of the length of blank section between the songs of the original recording, compressed audio discs play with a short pause between songs.

USB storage device

Playable folder hierarchy: up to eight tiers (A practical hierarchy is less than two tiers.)

Playable folders: up to 500

Playable files: up to 15 000

Playback of copyright protected files: No

Additional Information

Partitioned USB storage device: Only the first partition can be played.

There may be a slight delay when starting playback of audio files on a USB storage device with numerous folder hierarchies.

! CAUTION

Pioneer accepts no responsibility for data lost on the USB storage device even if that data is lost while using this unit.

iPod compatibility

This unit supports only the following iPod models. Supported iPod software versions are shown below. Older versions may not be supported.

- iPod nano 4th generation (software version 1.0.3)
- iPod nano 3rd generation (software version 1.1.3)
- iPod nano 2nd generation (software version 1.1.3)
- iPod nano 1st generation (software version 1.3.1)
- iPod touch 2nd generation (software version 2.2.1)
- iPod touch 1st generation (software version 2.2.1)
- iPod classic 120GB (software version 2.0.1)
- iPod classic (software version 1.1.2)
- iPod 5th generation (software version 1.3)
- iPhone 3G (software version 2.2.1)

Depending on the generation or version of the iPod, some functions can not be operated.

Operations may vary depending on the software version of iPod.

When using an iPod, iPod Dock Connector to USB Cable is required.

Pioneer CD-IU50 interface cable is also available. For details, consult your dealer.

Compatible file: MP3 (.mp3)/WAV (.wav)/AAC (.m4a)

Compatible format: AAC (16 Kbps to 320 Kbps), AAC VBR, Protected AAC (Purchased from iTunes Music Store)/MP3 (16 Kbps to 320 Kbps), MP3 VBR/Audible (Format 2, 3, 4), Apple Lossless, AIFF, WAV

Audio Book, Podcast: Yes

! CAUTION

Pioneer accepts no responsibility for data lost on the iPod even if that data is lost while using this unit.

Sequence of audio files

The user cannot assign folder numbers and specify playback sequences with this unit.

Example of a hierarchy

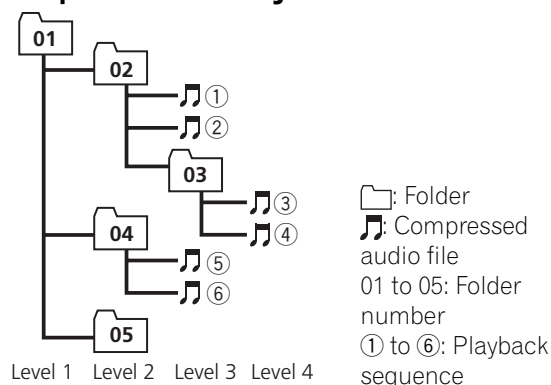

Disc

Folder selection sequence or other operation may differ depending on the encoding or writing software.

USB storage device

Playback sequence is the same as recorded sequence in the USB storage device.

To specify the playback sequence, the following method is recommended.

- 1 Create the file name including numbers that specify the playback sequence (e.g., 001xxx.mp3 and 099yyy.mp3).
- 2 Put those files into a folder.
- 3 Save the folder containing files on the USB storage device.

However, depending on the system environment, you cannot specify the playback sequence.

For USB portable audio players, the sequence is different and depends on the player.

Copyright and trademark

iTunes

Apple and iTunes are trademarks of Apple Inc., registered in the U.S. and other countries.

Additional Information

MP3

Supply of this product only conveys a license for private, non-commercial use and does not convey a license nor imply any right to use this product in any commercial (i.e. revenue-generating) real time broadcasting (terrestrial, satellite, cable and/or any other media), broadcasting/streaming via internet, intranets and/or other networks or in other electronic content distribution systems, such as pay-audio or audio-on-demand applications. An independent license for such use is required. For details, please visit <http://www.mp3licensing.com>.

WMA



Windows Media and the Windows logo are trademarks or registered trademarks of Microsoft Corporation in the United States and/or other countries.

This product includes technology owned by Microsoft Corporation and cannot be used or distributed without a license from Microsoft Licensing, Inc.

iPod



iPod is a trademark of Apple Inc., registered in the U.S. and other countries.

“Made for iPod” means that an electronic accessory has been designed to connect specifically to iPod and has been certified by the

developer to meet Apple performance standards.

Apple is not responsible for the operation of this device or its compliance with safety and regulatory standards.

iPhone



iPhone is a trademark of Apple Inc. “Works with iPhone” means that an electronic accessory has been designed to connect specifically to iPhone and has been certified by the developer to meet Apple performance standards.

Apple is not responsible for the operation of this device or its compliance with safety and regulatory standards. ■

Specifications

General

Rated power source	14.4 V DC (allowable voltage range: 12.0 V to 14.4 V DC)
Grounding system	Negative type
Maximum current consumption	10.0 A
Dimensions (W × H × D):	
DIN	
Chassis	178 mm × 50 mm × 165 mm
Nose	188 mm × 58 mm × 24 mm
D	
Chassis	178 mm × 50 mm × 165 mm
Nose	170 mm × 48 mm × 24 mm
Weight	1.3 kg

Audio

Maximum power output 50 W × 4

Additional Information

Continuous power output ...	22 W × 4 (50 Hz to 15 000 Hz, 5 % THD, 4 Ω load, both channels driven)
Load impedance	4 Ω (4 Ω to 8 Ω allowable)
Preout maximum output level	2.0 V
Tone controls:	
Bass	
Frequency	100 Hz
Gain	±12 dB
Mid	
Frequency	1 kHz
Gain	±12 dB
Treble	
Frequency	10 kHz
Gain	±12 dB

CD player

System	Compact disc audio system
Usable discs	Compact disc
Signal-to-noise ratio	94 dB (1 kHz) (IEC-A network)
Number of channels	2 (stereo)
WMA decoding format	Ver. 7, 7.1, 8, 9, 10, 11 (2ch audio) (Windows Media Player)
MP3 decoding format	MPEG-1 & 2 Audio Layer 3
WAV signal format	Linear PCM & MS ADPCM (Non-compressed)

USB

USB standard specification	USB 2.0 full speed
Maximum current supply ...	500 mA
Minimum memory capacity	256 MB
USB Class	MSC (Mass Storage Class)
File system	FAT16, FAT32
WMA decoding format	Ver. 7, 7.1, 8, 9, 10, 11 (2ch audio) (Windows Media Player)
MP3 decoding format	MPEG-1 & 2 Audio Layer 3
WAV signal format	Linear PCM & MS ADPCM (Non-compressed)

FM tuner

Frequency range	87.5 MHz to 108.0 MHz
Usable sensitivity	11 dBf (0.7 μV/75 Ω, mono, S/N: 30 dB)
Signal-to-noise ratio	72 dB (IEC-A network)

AM tuner

Frequency range	531 kHz to 1 602 kHz (9 kHz) 530 kHz to 1 640 kHz (10 kHz)
Usable sensitivity	25 μV (S/N: 20 dB)
Signal-to-noise ratio	62 dB (IEC-A network)

Infrared remote control

Wavelength	940 nm ±50 nm
Output	typ; 12 mw/sr per Infrared LED



Note

Specifications and the design are subject to modifications without notice. ■