



# M80 Series

**MODELS: M80i, M80S, M80G**  
**OPERATION & WIRING MANUAL**  
**5 YEAR GUARANTEE**  
**AS/NZS STANDARDS CERTIFIED**

**All models certified to AS/NZS4601 1999 amendment 1**  
**M80S also certified to AS/NZS3749.1 2003 Class B**  
**M80G also certified to AS/NZS3749.1 2003 Class A**

These products should be installed according to the requirements of the  
AS/NZS 3749.2 Installation Standard.  
Installation should only be carried out by suitably qualified persons.

References to alarm functions and siren/horn responses do not apply to model M80i.

# REMOTE CONTROL

## 2 'weatherproof' Remotes Supplied

### BUTTON TWO ONLY

PRESS FOR 3 SECONDS FOR  
'AUXILIARY OUTPUT' (EG: BOOT  
RELEASE)

### BUTTON TWO THEN ONE

'SILENT ARM or DISARM'  
THIS SEQUENCE WILL SILENTLY  
ARM OR DIS-ARM THE SYSTEM  
WITHOUT SIREN CHIRPS.

### BUTTON ONE & TWO TOGETHER

**1 sec 'CAR FINDER'**  
PRESS BOTH BUTTONS FOR 1 SECOND.  
SIREN SOUNDS BRIEFLY AND LIGHTS  
FLASH TO SHOW VEHICLE LOCATION

**3 sec 'PANIC'**  
PRESS FOR 3 SECONDS TO SOUND  
THE SIREN.  
PRESS BOTH AGAIN TO CANCEL.  
(Pressing button one during Panic, will either  
arm or disarm the system)

References to siren sounds and sensors  
only applies to alarm models.

### BATTERY REPLACEMENT

YOUR REMOTE CONTROL, USES 1 x 12v 27amp BATTERY WHICH IS AVAILABLE FROM  
YOUR MONGOOSE AGENT OR ELECTRONIC SUPPLY SHOP. PLEASE CHANGE ANNUALLY.



### BUTTON ONE ONLY

'ARM or DISARM'  
PRESS FOR 1.0 SECOND  
TO ARM OR DISARM THE  
SECURITY SYSTEM -  
(DOORS WILL ALSO LOCK OR  
UNLOCK IF THE CENTRAL  
LOCKING HAS BEEN  
CONNECTED)

### BUTTON ONE THEN TWO

'SENSOR BYPASS'  
THIS SEQUENCE DEACTIVATES  
ANY CONNECTED SENSOR.  
DOORS, BONNET & BOOT REMAIN  
PROTECTED AND ENGINE IMMOBILISED.  
*ONLY DEACTIVATE SENSORS TO  
REDUCE THE POSSIBILITY OF FALSE  
ALARMS.*

*These remotes are water resistant – not waterproof.  
If they get wet, disassemble as soon as possible,  
rinse in fresh water if contaminated by sea water,  
dry thoroughly and re-assemble.  
Water damage is not covered by warranty*

# CONTENTS

Automatic engine immobilisation..	4	Noise pollution control.....	9
Arming.....	5	Indicator flashing.....	10
Open circuit bypass.....	5	Dash mounted warning light...	10
Central locking.....	5	Chirp confirmation.....	10
Disarming.....	6	Car Finder & Panic.....	11
Security re-arm.....	6	Boot release.....	11
Silent arm/disarm .....	6	Programme options.....	12/13
Bonnet, boot & doors.....	6	Remote controls.....	14
2 stage impact sensor (excl' M80i)	7	Remote code learning.....	14/15
Glass break sensor.....	7	EMERGENCY OVERRIDE.....	16
Ultrasonic sensors (optional).....	7	PIN code programming.....	17
Microwave sensor (optional).....	8	Testing your alarm.....	18
Sensor disable.....	8		
Intrusion alert.....	8		
Battery back-up siren (M80S/AU/AM)	8	Wiring , programming & warranty	
Automatic re-set.....	9		
Arm condition memory.....	9	Proof of purchase	

## **OPERATING YOUR VEHICLE SECURITY SYSTEM**

### **AUTOMATIC 'TRIPLE CIRCUIT' ENGINE IMMOBILISATION**

**The engine will always automatically immobilise itself  
30 seconds after the ignition has been turned off.**

*This feature cannot be turned off or defeated as it is a mandatory  
'AS/NZS Standards' feature.*

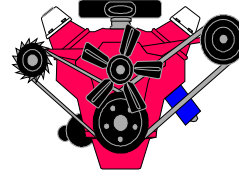

When you turn the ignition OFF, the dashboard LED will start to fast flash for 30 seconds to indicate the automatic sequence has commenced. At the end of the 30 seconds, the siren will chirp once (alarm models only), the indicators will flash once and the dashboard LED will slow flash as confirmation of immobilisation. Only the engine is immobilised, the alarm system is not yet armed.

If an attempt is made to start the engine whilst immobilised, the siren will chirp a warning – fully sounds if armed by remote.

**ONCE IMMOBILISED, PRESS BUTTON ONE TO DISENGAGE THE ENGINE IMMOBILISERS**

NOTE: If the system has automatically immobilised the engine and you now wish to arm the security system (& lock the doors), press button one twice.

The installer of this system will immobilise **three** of the following possible circuits to prevent engine starting;

- Starter motor
- Ignition system
- Electric fuel pump
- Other engine controlling circuit

Ask the installer which circuits are immobilised for future reference.

## **ARMING**

### **NORMAL OPERATION**

- ❑ Exit the vehicle and ensure all doors, bonnet & boot are closed.
- ❑ Press button **one** on the remote control.  
The indicators flash once and the siren chirps once to indicate that the system is armed.  
The dash board warning light, LED, will slow flash to indicate the system is armed.
- ❑ If your vehicle has central locking and it has been connected to this security system, the doors will lock at the same time as arming.

If the automatic engine immobiliser has activated before you wished to arm the system, **press button one twice** – once to disengage the immobiliser and a second time to fully arm (and lock the doors if connected) and immobilise the system. Note: The system can be programmed to arm automatically 30 seconds after the last door is closed. See page 12.

### **OPEN CIRCUIT BYPASS**

If any door, the bonnet or boot is left open when you arm the system, the siren will chirp once to signify the system is armed and then chirp again to inform you a circuit is still open. The dash mounted LED will flash a code for 30 seconds showing you what is open (see page 10). If ignored and not closed, that circuit will not be protected. The open circuit will automatically arm upon closure.

### **CENTRAL LOCKING - additional parts, at extra cost, may be required.**

This security system has built-in relays to operate a vehicles' existing central locking system by remote control. When connected, the doors will lock or unlock at the same time as arming or disarming.

### **SILENT ARM (no siren chirps)**

Press button **two** and then, within 2 seconds, button **one** to silently arm the system.  
The chirps may be permanently turned off via the programming options – see your installer.

## **DISARMING**

- ❑ Press button **one** on the remote control to disarm the system.  
The siren will chirp twice and the indicators will flash twice.
- ❑ The doors will unlock if the vehicles' central locking is connected to the security system.
- ❑ If a door is not opened within 30 seconds, the system will automatically re-arm (& re-lock if connected to your central locking) . See below.

### **SILENT DISARM (no siren chirps)**

Press button **two** and then, within 2 seconds, button **one** to silently disarm the system.

The chirps may be permanently turned off via the programming options – see your installer.

### **AUTOMATIC SECURITY RE-ARM**

The alarm will automatically fully re-arm (and re-lock the doors if connected) if it has been disarmed by remote but a door has not been opened within 30 seconds. The lights flash once as confirmation of re-arming. *This feature cannot be turned off.*

If a door, bonnet or boot is opened after disarming, the alarm will not re-arm and the doors will not re-lock. However, the engine will re-immobilise if the ignition is not turned ON within 30 seconds.

## **SECURITY PROTECTION**

### **IGNITION, BONNET, BOOT & DOORS – 30 second siren – 60 second light flash**

When armed, the siren will sound for 30 seconds and the indicators will flash for 60 seconds when any of these are triggered. If a door, bonnet or boot has been opened and left open, the siren will sound for 90 seconds (3 x 30 seconds) and the indicators will flash. The open circuit will then be bypassed.

(If programmed for NSW, the siren will sound once only for 30 seconds)

The system does require your vehicle to be fitted with courtesy light door switches for these to trigger the alarm. Fitting or replacing door switches will incur additional charges.

## **2 STAGE IMPACT SENSOR (M80S/G)**

This sensor is designed to detect impact to the vehicle such as to the bodywork or glass. It should not be triggered by normal wind, or rocking motions.

- ❑ If the sensor detects a light impact, the siren will sound a few warning chirps.
- ❑ If the sensor detects a heavier impact, the analyser circuit will determine this and sound the siren for 30 seconds and flash the lights.

The sensitivity level is set by the installer and should be at its optimum. Avoid over sensitivity as people nearby may not respond due to too many false alarms. (This type of sensor may not prevent wheel theft, we therefore advise the fitment of locking wheel nuts)

## **GLASS BREAK SENSOR (MODEL M80G)**

This sensor is designed to trigger the alarm by detecting the sound of actual glass breakage. The sensitivity level is set by the installer and should be at its optimum.

## **ULTRASONIC SENSOR (optional)**

The ultrasonic sensor fill the interior of your vehicle with high frequency sound and is designed to trigger the alarm when the interior environment changes. Possible changes are the breaking or removal of glass, a door being opened, or even strong wind through a slightly open window.

For the ultrasonic sensor to operate correctly ensure all doors and windows are closed when arming the alarm system. (False alarms are generally created by open windows or even strong wind through the air vents)

Due to the efficiency of this type of sensor, we advise that you do not leave people or animals inside the vehicle as any movement will trigger the alarm. Should you need to leave people or animals inside, follow the instructions for 'sensor disable by remote' to avoid the alarm being triggered.

### **MICROWAVE SENSOR (optional)**

The microwave sensor is designed to trigger the alarm when a microwave field registers physical movement. 2 fields are generated, one outside the vehicle to give perimeter protection, and one inside to give interior protection.

Intrusion into the perimeter area chirps the siren as a warning, whilst intrusion into the interior fully sounds the siren. The fields are adjustable for size and should have been set by the installer at their optimum. It is advisable to limit the exterior field to about the width of the door mirrors and the interior to approximately  $\frac{3}{4}$  of the vehicle width to avoid false alarms.

Do not leave people or animals inside the vehicle as any movement will trigger the alarm. Should you need to leave people or animals inside when arming, follow the instructions for 'sensor disable by remote' to avoid the alarm being triggered.

Note: As the microwave produces circular protective fields, some areas of the vehicle may not be protected due to its size and shape.

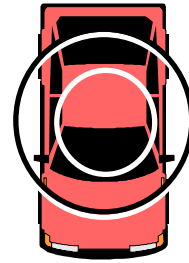

### **SENSOR DISABLE BY REMOTE (EXCEPT M80i)**

There are times when you may wish to deactivate sensors, such as the impact sensor, to prevent false alarms. To turn sensors off (any attached sensor will be disabled), but arm the bonnet, boot and doors and immobilise the engine, press button **one** followed by button **two**. You will hear the siren chirp for arming followed by a tone indicating the sensors are turned off. The sensor is re-activated upon subsequent arming.

### **INTRUSION ALERT**

Upon disarming, if the siren chirps 4 times and the indicators flash 3 times the system tells you that it has been triggered. Refer to the LED flash codes on page 10 to show which circuit has been triggered.



**BATTERY BACK-UP SIREN (M80S/G)**

These models have a battery back-up siren. Vehicle battery disconnection will cause the battery back-up siren to sound. The siren can be turned off with the special keys provided.

The siren is mounted under the bonnet and should be situated in a place to protect it from heat and water damage. Driving through deep water or puddles may cause water splashes, so caution is advised. Please check that the siren has been mounted in such a position so as to avoid damaging it. If washing the engine bay, cover the siren with a plastic bag to prevent water damage. Heat or water damage is not covered by the warranty.

**AUTOMATIC RE-SET**

Upon an intrusion (ie; door opened and closed), the siren will sound for 30 seconds, after which it will stop and reset to the armed position. It will then re-trigger on the next intrusion.

If a door is left open, the siren will sound for 3 x 30 seconds and then that individual circuit will be bypassed to avoid unnecessary noise.

(NSW, one sounding only - must be manually re-set after first trigger)

**ARM CONDITION MEMORY**

Should the vehicle battery be disconnected, the system memorises the last set position of the alarm.

If the alarm was disarmed prior to battery disconnection, reconnection does not cause the alarm to sound. If the battery was disconnected whilst the system was armed, reconnection will return the system to the armed state.

**NOISE POLLUTION CONTROL**

To reduce noise nuisance and possible false alarms, the system will isolate an individual circuit if it is triggered more than three times in succession or is left open.

(Eg: 3 x bonnet, 3 x boot, 3 x doors, 3 x ignition, 3 x impact sensor, 3 x other sensor)

Reset by remote by disarming and then re-arming. Turn ignition ON/OFF to re-set LED intrusion codes.

### INDICATOR FLASHING (FUSE PROTECTED)

When the siren sounds, the indicators flash simultaneously.

The indicators will also flash on arming and disarming the system.

- a) 1 Flash - Armed.
- b) 2 Flash - Disarmed.
- c) 3 Flash - Disarmed and previously triggered.
- d) On permanently – Open circuit after arming, or Perimeter Nite Lite is on



### LED - DASH MOUNTED WARNING LIGHT

The LED shows the status of the alarm, intrusion and any open circuit when arming.

- a) Fast flashing - 30 second countdown of automatic functions.
- b) Slow flashing - system armed.
- c) LED off - system off.
- d) On permanently - in remote code learning mode
- e) 1 flash, pause - bonnet is open or triggered.
- f) 2 flash, pause - boot is open or triggered.
- g) 3 flash, pause - a door is open or triggered.
- h) 4 flash, pause - impact sensor has been triggered.
- i) 5 flash, pause - engine start attempted
- j) 6 flash, pause - 2<sup>nd</sup> sensor port triggered



### CHIRP CONFIRMATION & CODES

- a) 1 Chirp - Arm.
- b) 1 Chirp/short siren - Indicates an open circuit when arming.
- c) 2 Chirps - Disarmed.
- d) 4 Chirps - Disarming and indicates that the alarm has been triggered.
- e) Continual chirps - Ignition has been turned on when the engine is immobilised

### **CAR FINDER**

As many cars these days look very similar, this handy feature lets you find your car in a crowded car park. Press both remote buttons for 1 second. The siren sounds for 2 seconds and the indicators flash for 10 seconds. (Assuming the vehicle is within remote range)

### **PANIC BY REMOTE (in either armed or disarmed state)**

In the event of personal attack, or you suspect that your vehicle is being tampered with, the alarm can be 'panicked' by pressing buttons **one** and **two** at the same time on the remote for more than 3 seconds. The siren will sound and the indicators will flash.

Cancel the panic, by pressing both buttons again.

Pressing button one whilst the siren is sounding will either arm or disarm the system depending on the prior armed/disarmed state.

### **LIGHTS ON WARNING**

This helps to prevent your car battery going flat if you accidentally left the vehicle lights on when exiting your vehicle. If the lights are on when you arm the system, the siren will chirp once and then briefly produces a different sound as a warning. If you intended to leave the lights on, ignore this warning.

### **BOOT RELEASE (AUXILIARY OUTPUT) – OPTIONAL CONNECTION**

The system provides an output which may be optionally connected to control a vehicle's electric boot release (if the vehicle is equipped). This may incur additional charges.

- Press button two on the remote for 3 seconds and the boot will unlock and open
- The boot trigger circuit and interior sensors (if fitted) will be bypassed
- Upon closing the boot the bypassed circuits will re-arm automatically

## **PROGRAMMABLE OPTIONS**

These should only be changed by your installer.

### **AUTOMATIC (LAST DOOR) ARMING (default = OFF)**

When programmed ON, the alarm will arm automatically 30 seconds after the last door is closed.

- If the engine immobilises prior to the opening and closing of a door, this feature will commence and the LED will fast flash when you close the last door.
- The doors will not lock to prevent the keys being locked inside unless option 2 above is also turned on.

### **AUTOMATIC DOOR LOCK (default = OFF)**

The doors will lock automatically 30 seconds after the last door is closed.

**WARNING: DO NOT LEAVE THE KEYS IN THE CAR !**

This feature only operates if 'last door arming' above has been programmed ON.

### **IGNITION SAFETY DOOR LOCK (default = OFF)**

If the system has been connected to a vehicles' central locking, the doors will lock 3 seconds after the ignition is switched 'on' and unlock immediately when the ignition is turned 'off'.

If a door is left open whilst starting the engine this feature will be bypassed.

### **SIREN CHIRPS (default = ON)**

The chirps can be permanently turned off. Only the indicators confirm the arming and disarming. We suggest that you use the 'silent arming by remote' feature as an alternative to turning them off permanently as it is desirable for the system to chirp in public places to warn others that you have a security device fitted to your vehicle.

**NSW SIREN TIMING (default = OFF)**

It is a mandatory requirement in New South Wales, Australia, for vehicle alarm systems to sound the siren for one cycle of 30 seconds only before it is re-set manually by remote control. With this feature turned on, the indicators will flash for any subsequent trigger.

**PERIMETER NITE-LITE (default = OFF)**

Upon disarming, the indicators will stay permanently lit for 15 seconds to provide perimeter illumination. Ask the installer to verify that the power consumption of all the indicators is within the tolerance of this product- maximum 8 amps per side.

**SIREN/HORN OUTPUT (default = siren)**

This programme allows for connection to a vehicle horn. The output is then pulsed.

**DOOR DIAGNOSTICS (default = ON)**

This is factory set to ON. If for example a door is left open when arming, the siren chirps once for ARM then after a short pause, chirps a second time to signify a circuit is open. Some vehicles which have 'dome light delay' may give a false signal – this feature should then be programmed OFF.

**TURBO FUNCTION (default = OFF)**

This allows an engine to remain running from a turbo timer so you can arm the bonnet, boot & doors (and lock the doors if connected to central locking). When the turbo timer stops, the triple immobilisers and any connected sensor become active after a 10 second delay. Any intrusion whilst the engine is running will sound the alarm and immediately immobilise the engine.

### **ROLLING CODE REMOTE CONTROLS**

Two weatherproof (shower-proof) remote controls are supplied with the system which enable you to arm and disarm your security system. If the remote gets wet due to submersion, immediately dismantle, remove the battery and dry as soon as possible. If submersed in salt water, rinse in fresh water and dry.

Water ingress and any subsequent remote failure is not covered under the warranty terms.

The remote security code of your alarm system changes each time you press the remote button. This coding system is referred to as Rolling Code and is completely random therefore eliminating the possibility of anyone recording it (code grabbing).

The batteries in the remote controls should be changed when you notice any of the following;

- System does not respond to the remote signal
- Operation is intermittent
- Reduced operating range
- The remote LED fails to light

Replace annually with a 12v 27A alkaline battery.

### **REMOTE CODE LEARNING**

The main alarm module has a learning capacity to memorise up to four remote controls.

If you wish to add further remotes or a remote has to be replaced, the new remote needs to be code learnt into the main module. If for instance you have lost a remote, and are fearful that someone may try to use it, the lost remote can be deleted from memory so it cannot be used.

An irregular or interruption to the vehicle's power supply may cause loss of remote memory. If your alarm fails to respond to the remote try re-learning them, or see your Mongoose dealer.

#### REMOTE CODE LEARNING cont'

- ❑ Disarm the system
- ❑ Open the drivers door and leave open
- ❑ Within 15 seconds, turn the ignition ON/OFF 3 times (ignition remains off)
- ❑ The siren will chirp 3 times, the indicators will flash 3 times to confirm you have entered remote code learning mode. (no chirps on M80i unless siren/horn connected)
- ❑ Press button one on the first remote – siren will chirp once as confirmation of reception
- ❑ Press button one on the second remote – siren will chirp twice as confirmation of reception
- ❑ Repeat for up to four remotes (siren will chirp 3 times for the third and 4 times for the fourth).
- ❑ Leave the system for 10 seconds or turn the ignition on to end code learning mode. This is confirmed by three fast chirps and light flashes.

***NOTE: When learning a new replacement or additional remote, the original remote(s) must be re-learnt or they will be erased from memory and will not operate this system.***

#### **To delete a remote from memory:**

If you lose a remote, it is recommended that it is deleted from memory so someone else cannot use it. Enter learning mode as detailed above and memorise the existing remote(s) once. The lost remote is now deleted. When a replacement is obtained, learn both the existing and new remotes into memory as detailed above.

## **EMERGENCY OVERRIDE – 4 DIGIT PIN CODED**

If all remotes are lost or inoperable, the system can be disarmed by entering your the unique 4 digit PIN code issued with this product.  
**KEEP THE CARD IN A SAFE PLACE – NOT IN THE VEHICLE !**



Following is an example using PIN code **4525**

The code is entered by turning the ignition ON or OFF in sequence with the dash mounted LED.

- 1) **Ignition ON** - LED will light permanently to commence override.
- 2) **Ignition OFF** - LED will start flashing. Count the number of flashes for the first number.
- 3) **Ignition ON** - after 4 flashes (1<sup>st</sup> number of the example). The LED will light.
- 4) **Ignition OFF** - count the number of flashes.
- 5) **Ignition ON** - after 5 flashes (2<sup>nd</sup> number). The LED will light.
- 6) **Ignition OFF** - count the number of flashes.
- 7) **Ignition ON** - after 2 flashes (3<sup>rd</sup> number). The LED will light.
- 8) **Ignition OFF** - count the number of flashes.
- 9) **Ignition ON** - after 5 flashes (4<sup>th</sup> number).
- 10) **The system will now disarm and the vehicle can be started.**

Note: If your PIN code contains a "0", this equals '10'.

Should you miss the LED flashes or enter a digit incorrectly, wait for 11 flashes and simply repeat the procedure from step 1).

This system will always automatically immobilise the engine every time the ignition is turned off. This override sequence will have to be used until the remotes are repaired or replaced.



### **OVERRIDE PIN CODE PROGRAMMING**

Your security system is pre-programmed with a unique 4 digit PIN code as shown on the 'PIN code card'. You may wish to have your own code programmed to a number that is easier to remember. **Once changed, the factory setting is permanently erased.**

- 1 Disarm the system using the remote control.
- 2 Disconnect all power feeds *including the central locking connections* to this system for 10 seconds (or disconnect the car battery – radio pre-sets/code will have to be re-set).
- 3 Reconnect the power and turn the ignition ON then OFF once.
- 4 Open & close the door (or press door switch) 5 times and leave closed.  
The siren will give one long chirp and the lights will stay on to show learning mode.  
If the code is, for example, 2-3-3-4
- 5 Turn ignition ON.  
The LED lights for 3 seconds to show the start of the learning sequence. The LED will then start to slow flash.
- 6 Allow the LED to flash twice for the first digit (2), then turn ignition OFF.  
The LED will light for 2 seconds to confirm 1<sup>st</sup> digit input.
- 7 Turn the ignition ON and the LED starts to slow flash again.
- 8 Repeat steps 6 & 7 for the 2<sup>nd</sup>, 3<sup>rd</sup> & 4<sup>th</sup> digits.
- 9 After the 4<sup>th</sup> digit is accepted the PIN code learning programme will cease.  
(Turning ON the ignition & opening a door will also cancel this learning mode)  
**ARM THE SYSTEM AND TEST THE OVERRIDE PIN CODE FOR CORRECT OPERATION.**
- 10 Amend the PIN code card with the new number, but do not leave in the vehicle !

## **TESTING YOUR ALARM**

*We strongly recommend that you frequently test your alarm.*

- 1) Without disarming the system, unlock and open a door with the ignition key - the alarm should sound, excluding model M80i. Check all other doors, bonnet and boot by the same procedure.
- 2) Check the impact sensor, M80S/G, by giving the vehicle varying degrees of impact - be careful to do this on areas of the vehicle not likely to be damaged by impact. Light impacts should chirp the siren whilst heavier impacts should fully sound the siren.
- 3) Check the glass break sensor, M80G, by tapping the glass with a 50 cent coin. Varying degrees of tapping should be tried to see the level of sensitivity. Be careful not to break the glass.
- 4) Enter the vehicle and shut all doors, arm the system by remote and try to start the engine to test the engine immobiliser - it should not start and the siren (if fitted) should sound.
- 5) To test the optional ultrasonic sensors, if fitted, enter the vehicle, shut all doors and windows, arm the system and allow it to stabilise for 10~20 seconds. Now wave or clap your hands – the alarm should sound.
- 6) To test the optional microwave sensor, if fitted, arm the system and wait at least 10~20 seconds for the sensor to stabilise. Moving a hand over the outside of side windows should chirp the siren.  
To test the perimeter field size, repeat this movement on the outside of all glass areas.  
To test the interior, leave a window open when arming and reach in and wave an arm around - the siren should fully sound.

**WIRING INFORMATION:** Installation to be carried out by suitably qualified persons.

**MAIN MODULE** The wires printed for the function;

- |     |                       |       |    |                           |       |
|-----|-----------------------|-------|----|---------------------------|-------|
| 1)  | (+) INDICATOR – 8 amp | FUSED | 1) | ORANGE – UNLOCK – NO      | FUSED |
| 2)  | (+) 12V               | FUSED | 2) | BLUE – UNLOCK – COMMON    |       |
| 3)  | (+) INDICATOR – 8 amp | FUSED | 3) | BROWN – UNLOCK – NC       |       |
| 4)  | (-) DOME LIGHT        |       | 4) | BLACK – GROUND WHEN ARMED |       |
| 5)  | (+) SIREN             |       | 5) | WHITE – LOCK – NC         |       |
| 6)  | (-) BONNET TRIGGER    |       | 6) | GREEN – LOCK - COMMON     |       |
| 7)  | (-) BOOT TRIGGER      |       | 7) | PURPLE – LOCK – NO        | FUSED |
| 8)  | (-) GROUND            |       | 8) | YELLOW – 2 STAGE UNLOCK   |       |
| 9)  | (-) GROUND            |       |    |                           |       |
| 10) | (+) PARK LIGHT        |       |    |                           |       |
| 11) | (-) Ch 2              |       |    |                           |       |
| 12) | (+) DOOR TRIGGER      |       |    |                           |       |
| 13) | (-) DOOR TRIGGER      |       |    |                           |       |
| 14) | (+) IGNITION          | FUSED |    |                           |       |

IMMOBILISER CIRCUIT #1, #2, #3      PAIRED WIRES – 2 pairs for each circuit

Note: Turbo function.

Connect the turbo run wire before the ignition immobiliser cut and turn programme #13 ON.

**WIRING - mount module in a secure place where it cannot be seen or tampered with**

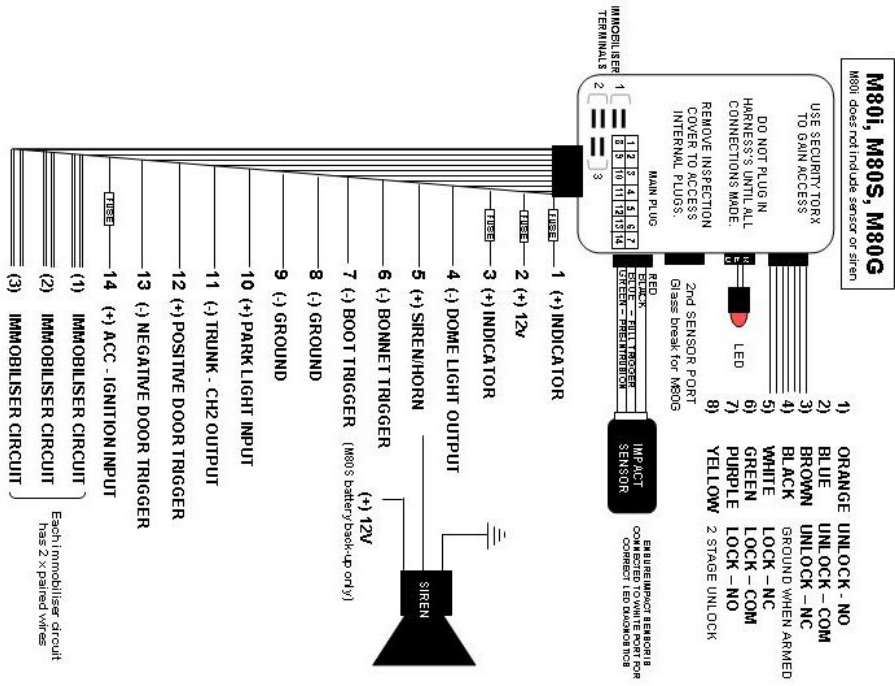

**ALL WIRE LABELS MUST BE REMOVED**

**SIREN / BONNET LOOM – BULLET CONNECTED**  
**ALL BLACK WIRING – PRINTED WITH FUNCTION**

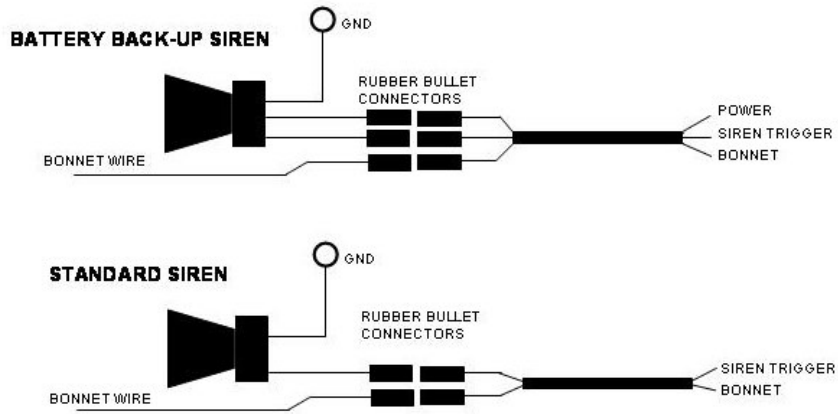

General installation instructions are available on the Mongoose internet site:  
[www.mongoose.com.au](http://www.mongoose.com.au)  
Access is password restricted to Mongoose authorised installers.

# CENTRAL LOCKING CONNECTION OPTIONS

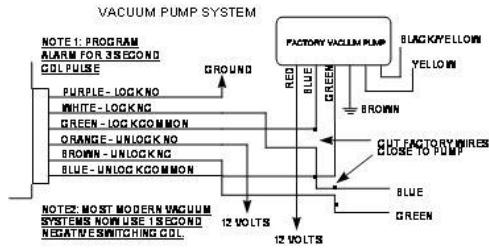
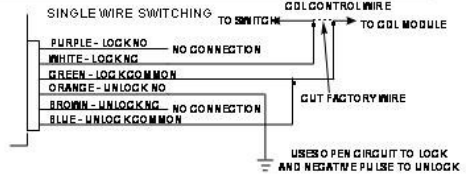
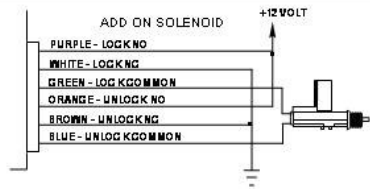
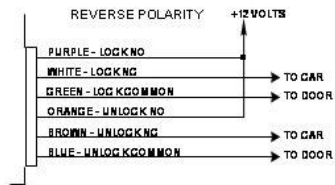
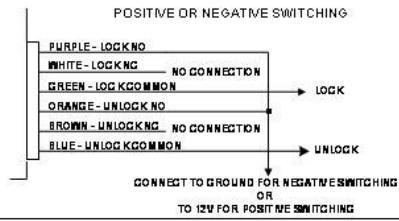

PROGRAMME OPTIONS (no chirps for M80i unless siren/horn connected)

1. Ensure the drivers door is open
2. Within 15 seconds of opening the door, turn the ignition ON/OFF the number of times relative to the programme chart (eg: 4 times for ignition door lock).
3. Siren will then chirp the same number of times as the programme number and the lights also flash the same number of times
4. Press button one to turn the feature "ON" - siren chirps once – lights flash once
5. Press button two to turn feature "OFF" - siren chirps twice – lights flash twice
6. Leave system for 10 seconds - system fast chirps 3 times (lights flash 3 times) to signify end of programming

\* = FACTORY DEFAULT

	FEATURE	BUTTON ONE	BUTTON TWO
3	REMOTE CODE LEARNING	See page 13	
4	IGNITION DOOR LOCK	ON	OFF*
5	SIREN CHIRPS	ON *	OFF
6	CDL PULSE	0.8 Secs *	3.5 Sec.
7	SIREN OR HORN	SIREN *	HORN
8	DOOR DIAGNOSTICS	ON *	OFF
9	NSW SIREN TIMING	ON	OFF *
10	LAST DOOR ARMING	ON	OFF *
11	AUTO DOOR LOCK	ON	OFF *
12	PERIMETER NITE LITE	ON	OFF *
13	TURBO FUNCTION	ON	OFF *

# WARRANTY CONDITIONS

## PRODUCT WARRANTY

Mongoose warrants for a period of 60 months that it will make good without charge at Mongoose's discretion, by repair or replacement with a reasonable equivalent, any defect in the product providing that;

- (a) the defect has been notified as soon as it is noticed to an authorised Mongoose installation centre, distributor or agent (in the first instance to the original installation centre).
- (b) the alarm is less than 5 years of age from the date of sale and was manufactured within the last 6 years.
- (c) the alarm has been installed by an approved Mongoose installation agent
- (d) it has been installed according to the AS/NZS 3749.2 Installation Standards and/or to our written instructions.
- (e) provision of proof of purchase stating where it was purchased and by whom it was installed.
- (f) if the alarm is installed by anyone other than an approved Mongoose installer a 12 month parts only warranty applies
- (f) an authorised installation centre has determined that the defect complained of is a genuine product defect and not caused by;
  - (i) incorrect installation or any other consequential damage caused by the vehicle or other vehicle parts
  - (ii) operation of alarm after it is known to be defective
  - (iii) alteration or modification of the alarm or its components
  - (iv) the fitment of additional security parts or accessories not supplied by or approved of by Mongoose
  - (vi) any work carried out on the alarm by someone other than an authorised Mongoose installation centre
  - (vii) misuse, accident, deliberate act or abuse (eg: misdirected electrical current, ingress of water or fluid, vehicle damage)

## Exclusions:

- (i) removal & refitting costs of parts
- (ii) mobile service costs
- (iii) batteries, i.e. remote controls
- (iv) normal wear and tear
- (v) alarms operated outside the original country of purchase
- (vi) freight costs of parts to rectification centres
- (vii) transport costs of getting a vehicle to a repair centre
- (viii) consequential costs of vehicle non-operation where the remote controls or PIN code card are lost, not available, or an inability to use

## INSTALLATION WARRANTY

Warranty for the installation is borne by the original installing agent only.

The period and terms of warranty are determined by the installation agent and should be verified with them.

Rectification work required to correct an installation fault carried out by anyone other than the original installation agent will incur their charges.

Authorisation to have this work carried out and agreement to have any costs refunded should be obtained from the original installation agent prior to work commencing.

Whilst every care is taken in fitting the security system, Mongoose accepts no responsibility for any damage caused to a vehicle in the installation process. Responsibility is borne by the installer.

## THIS WARRANTY IS ONLY TRANSFERABLE AS PRESCRIBED AS BELOW

- a) If the vehicle is sold with this product, the new owner receives the balance of the warranty but up to a period of 3 years.
- b) If the original owner has the system re-installed into an alternative vehicle by an authorised Mongoose installation centre, the owner receives the remaining period of warranty. If re-installed by an unauthorised person, this warranty ceases.



The Mongoose M80 models are manufactured, tested and certified to the Australian and New Zealand Standards for vehicle security systems.

Manufactured for: Mongoose (Australia) Pty Ltd  
Make & Model Number: Mongoose M80 Series  
Country of manufacture: Taiwan R.O.C.  
Supply voltage: 12v DC nominal – negative ground  
Current consumption: 14~22mA (depending on alarm accessories)  
Suitability: All vehicles with 12v negative earth batteries  
Date of manufacture: Refer date code on alarm module case

AS/NZS3749.1 2003 Class A & B definition: includes control equipment including setting and unsetting facilities, all sensors, warning devices and provision for immobilisation of the vehicle.

Whilst this security system provides a deterrent, it may not prevent theft or damage through wilful criminal intent.

Mongoose does not by inference, intent or any other means guarantee that a vehicle fitted with one of its security systems will not be stolen, broken into, tampered with, or parts taken. Mongoose does not offer nor will pay compensation for any loss. We recommend adequate vehicle insurance and the fitment of other security devices as deemed necessary.

The loss and any associated costs of replacing the remote controls and/or PIN code card in making the vehicle mobile (or towage) are the responsibility of the vehicle owner/driver.



## Installation Certificate

We confirm this Mongoose security system has been installed into the vehicle detailed below, to the requirements of AS/NZS 3749.2:1997 or subsequent 'Installation Standards'.

### VEHICLE DETAILS

Make/Model: \_\_\_\_\_ Registration No': \_\_\_\_\_

### INSTALLATION DETAILS

Product Model Number: \_\_\_\_\_ Certified to: AS/NZS \_\_\_\_\_

Product supplied by: \_\_\_\_\_  
(Company name)

Product installed by: \_\_\_\_\_  
(Company name)

Installers Name: \_\_\_\_\_

Installer Signature: \_\_\_\_\_ Date installed: \_\_\_\_\_

# PROOF OF PURCHASE

DO NOT LEAVE THIS INFORMATION IN THE VEHICLE

OWNERS NAME:..... VEHICLE MAKE:.....

ADDRESS:..... VEHICLE MODEL:.....

..... VEHICLE REG' NO:.....

TELEPHONE NO:..... ALARM MODEL NO:.....

ALARM PURCHASED FROM:.....

DATE PURCHASED:.....

INSTALLED BY:.....

DATE INSTALLED:.....

INSTALLER SIGNATURE:.....

OWNERS SIGNATURE:.....

Dealer
--------

Please complete the above details, detach from this manual and keep in a safe place. These details should be presented to your Mongoose dealer in the unlikely event that you require this product to be repaired under the terms of the 'product warranty'. Refer 'Warranty Conditions'. Failure to provide this 'Proof of Purchase' may result in rectification charges being made. If you sell the vehicle within the warranty term, please pass on this on to the new owner.