

MARINE WIRED REMOTE

MS-WR100G
MS-WR100C

INSTALLATION

The MS-WR100 is a plug and play device. Connect to the CANbus cable connection on your FUSION Marine Headunit.

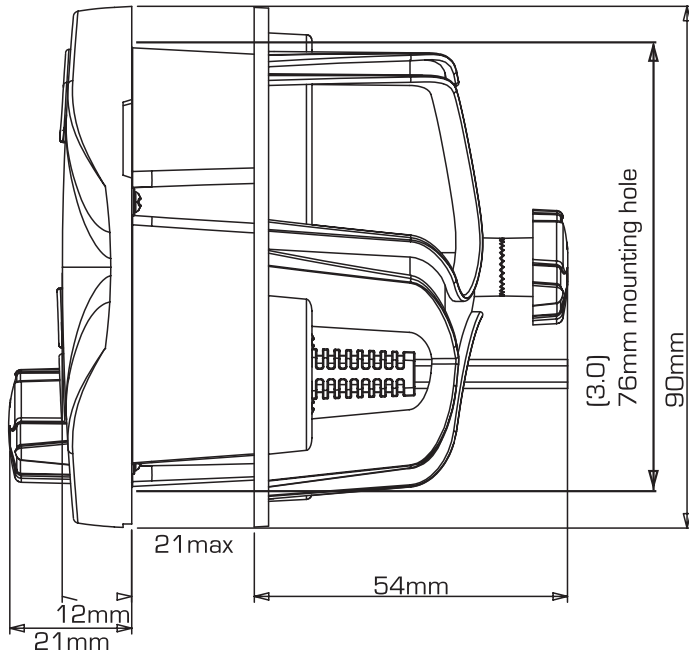

RECORD YOUR PRODUCT DETAILS HERE:

MODEL NUMBER _____

DATE OF PURCHASE _____

AFFIX RECEIPT HERE _____

PUBLISHED BY FUSION ELECTRONICS LIMITED:
© Copyright 2008 by FUSION Electronics Limited.
All rights reserved. Specifications and design are
subject to change without notice.











YOU CAN HELP PROTECT THE ENVIRONMENT!
Please remember to respect the local regulations:
Hand in the non-working electrical equipment
to an appropriate waste disposal center.

Version 1.0



BUTTON DESCRIPTION

BUTTON	DESCRIPTION
	Power Press to turn the unit ON/OFF
	Source Press to select the desired source Radio (FM-AM-SAT) - CD/MP3 - iPod - AUX
	Mute Press to Mute/Un-Mute sound in all zones
	Menu Press to enter menu system. Press to return to previous screen.
	Play/Pause Play/Pause track in CD/MP3 and iPod mode.
	Back/Previous Short Press: To select the previous track in CD/MP3 and iPod mode. Start automatic tuning down the frequency spectrum in the tuner mode. Press and Hold: Rewind in CD/MP3 and iPod mode. Start manual tuning down the frequency spectrum in the tuner mode.
	Forward/Next Short Press: To select the next track in CD/MP3 and iPod mode. Start automatic tuning up the frequency spectrum in the tuner mode. Press and Hold: Fast forward in CD/MP3 and iPod mode. Start manual tuning up the frequency spectrum in the tuning mode.
	Rotary Encoder The Rotary Encoder operates the same way as the Rotary Encoder on your FUSION Marine Stereo Unit

OPERATION





ALLOCATING ZONES FOR THE REMOTE.

Press and hold the Mute Button for 7-10 seconds then turn the  to select a zone (Z1, Z2, Z3, Z4, Z1234). Press to select. The Remote will then shut down and will need to be turned on.

ZONE VOLUME

Turn the  to adjust the volume in the allocated zone

GENERAL SETUP

1. Press the  and turn the  to select the Setup menu. Press to enter.
2. Turn the  to select the function and press to enter.
3. Turn the  to adjust and press  to return.

ACCESSORIES AVAILABLE:

MS-RM100EXT 20 meter extension cable
MS-RM100Y Y splitter cable

Please refer to the MS-CD500/MS-IP500 Marine Headunit manual for detailed Operation Instructions.