

Uniden®

SOLARA DSC

FIXED MOUNT VHF MARINE TWO-WAY RADIO



SOLARA DSC

SOLARA DSC BK



Uniden advanced marine technology

www.uniden.com

Maritime Radio Services Operation

Warning!

This transmitter will operate on channels/frequencies that have restricted use in the United States. The channel assignments include frequencies assigned for exclusive use of the U.S. Coast Guard, use in Canada, and use in international waters. Operation in these frequencies without proper authorization is strictly forbidden. For frequencies/channels that are currently for use in the U.S. without an individual license, please contact the FCC Call Center at 1-888-CALL-FCC.

For individuals requiring a license, such as commercial users, you should obtain a license application from your nearest FCC field office.

Uniden works to reduce lead content in our PVC coated cords in our products and accessories.

WARNING: The cords on this product and/or accessories contain lead, a chemical known to the State of California to cause birth defects or other reproductive harm. ***Wash hands after handling.***

Contents

Uniden SOLARA DSC	2
Included with your SOLARA DSC	3
Controls and Indicators.....	4
Installation.....	7
Choosing a Location.....	7
Engine Noise Suppression	8
Antenna Considerations	8
Antenna Selection and Installation.....	8
Installing the SOLARA DSC	9
Operation	10
Power On/Off.....	10
Last Channel Memory	10
Squelch.....	11
Coast Guard Channel 16/Channel 9 Communications	12
Selecting a Channel	12
Weather Channels	12
All Channel Scan.....	13
Weather Alert.....	13
Setting the Transmit (TX) Power	14
Recommended Emergency Broadcast Instructions	15
Distress.....	16
Digital Selective Calling (DSC).....	17
Individual	17
All Ships	18
User MMSI.....	20
NMEA Technical Setup	21
Optional Accessories	21
VHF FM Marine Radio Telephone	
Channel and Functions (USA Channels)	22
Channel and Functions (International Channels)	23
Channel and Functions (Canadian Channels).....	24
Specification	25
Troubleshooting	26
Care and Maintenance	27
Three Years Limited Warranty	29

Uniden SOLARA DSC

The Uniden **SOLARA DSC** VHF marine radio has been designed to give you a rugged, reliable instrument that will provide you with years of trouble-free service.

With proper care and maintenance, your marine radio could outlast your present vessel and serve you well on-board. The full features and flexibility designed into this quality transceiver will prevent it from becoming obsolete regardless of changes in craft or geographic locations.

The technical excellence of this marine radio is demonstrated by the multiplicity of uses for which it has been found acceptable by the U.S. Federal Communications Commission. It is acceptable for compulsory use on "party boats", for use on vessels subject to the Great Lakes Radio Agreement or bridge-to-bridge requirements, for general pleasure and commercial vessels, and certain land stations in marine service.

The **SOLARA DSC** is of all solid-state design with conservatively rated, rugged components and materials compatible with the marine environment. The transceiver utilizes a number of gaskets, sealing rings, waterproof membranes, and other sealants to effect a waterproof housing for protection of the electronics. It meets the most stringent JIS7 waterproof specification. The unit may be mounted in any number of convenient locations on your vessel by utilizing the optional flash mount bracket (White - FMB322W, Black - FMB322B).

You are encouraged to thoroughly read the rest of this Operating Guide to acquaint yourself with the characteristics and operation of your transceiver so that you can contribute to the longevity of your investment.

Keep your receipt as proof-of-purchase in case warranty service is required.

Features, specifications, and availability of optional accessories are all subject to change without notice.

Note: **SOLARA DSC** meets JIS7 requirements.

The color of your **SOLARA DSC** may vary.

Included with your SOLARA DSC

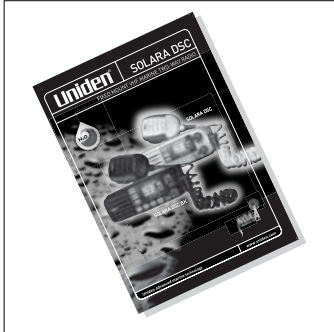

SOLARA DSC
Owner's Manual

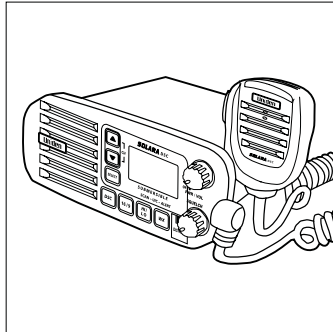

SOLARA DSC Radio

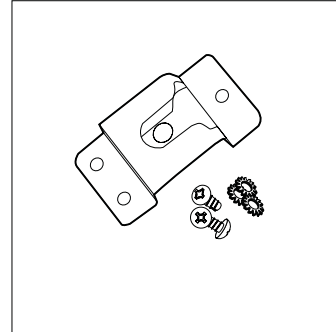

Microphone Hanger
and Screws

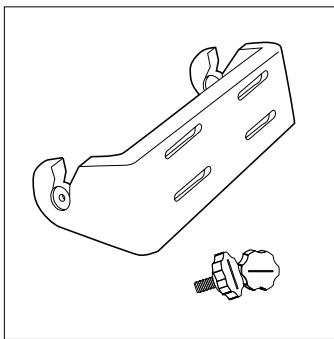

Mounting Bracket
and Knobs

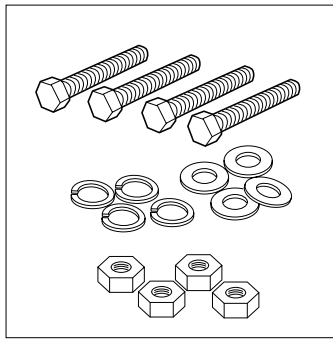

Mounting Hardware

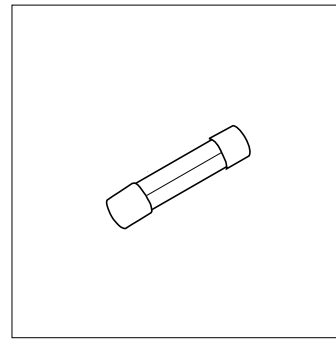

Spare Fuse
250V 6A

Controls and Indicators

Front panel/Microphone

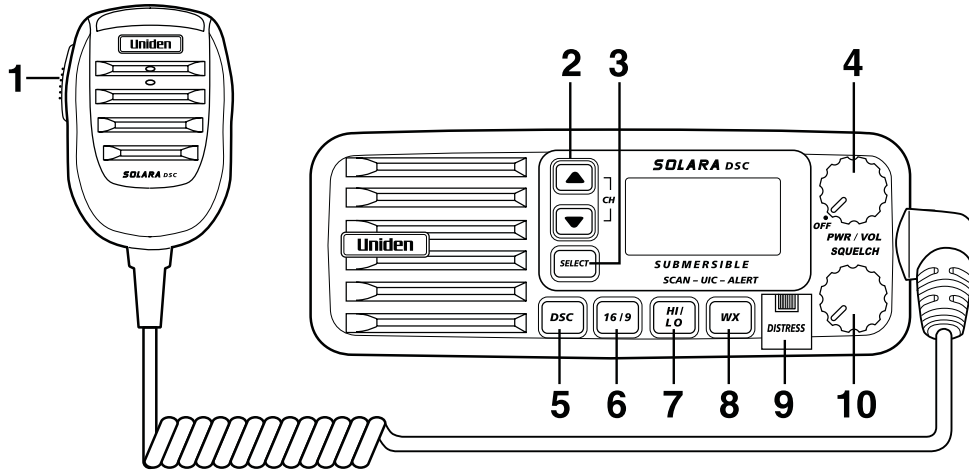

1. **PTT Switch** - Press to transmit and release to receive.
2. **CHANNEL/▲/▼** - These keys are used to change the channel number up/down. These buttons are also used to move the cursor in DSC Menu mode.
3. **SELECT** - In the DSC Menu mode this is used to select the DSC menu options.
4. **PWR/VOL (On/Off/Volume)** - Turns the unit On or Off and adjusts the speaker volume.
5. **DSC** - Press this key to activate DSC Menu mode.
6. **16/9** - Press this key instantly change to Channel 16, Channel 9 or current channel.
7. **HI/LO/SCAN/UIC** - Press this key to change the transmit power to either High or Low. Press and hold this key for 2 seconds to place the radio into the Scan mode. Press both HI/LO/SCAN/UIC and WX/ALERT/UIC at the same time to change channel modes from USA to INTERNATIONAL to CANADIAN.
8. **WX/ALERT/UIC** - Press this key to listen to active NOAA Weather channels. Press and hold this key for 2 seconds to place the radio into the Weather Alert mode. Press both HI/LO/SCAN/UIC and WX/ALERT/UIC at the same time to change channel modes from USA to INTERNATIONAL to CANADIAN.
9. **DISTRESS** - Press this key to send a signal of distress in case of emergency.
10. **SQUELCH** - Rotate this knob eliminate background noise when a signal is not being received.

Rear Panel Connectors

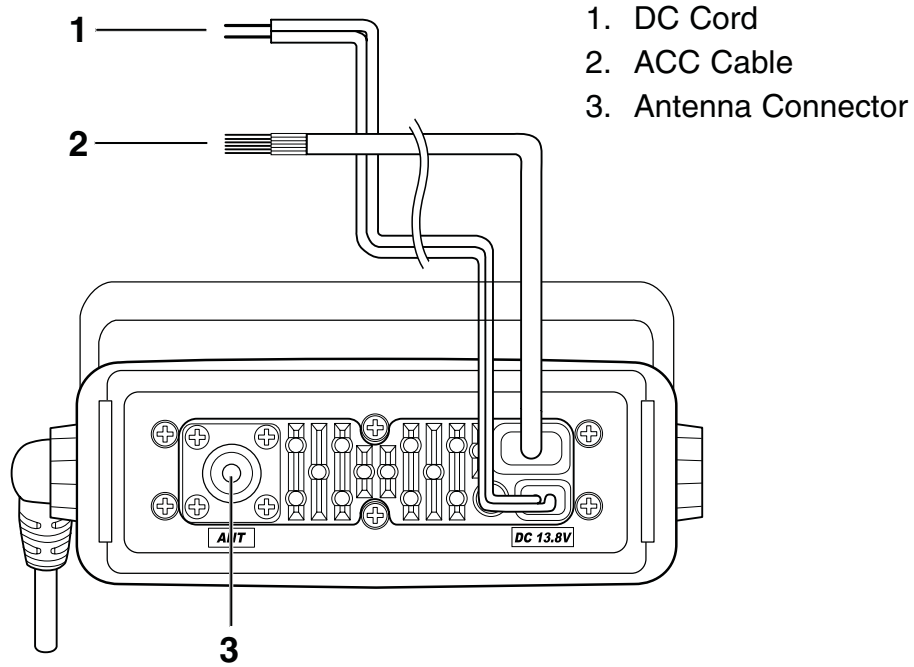

ACC Cable

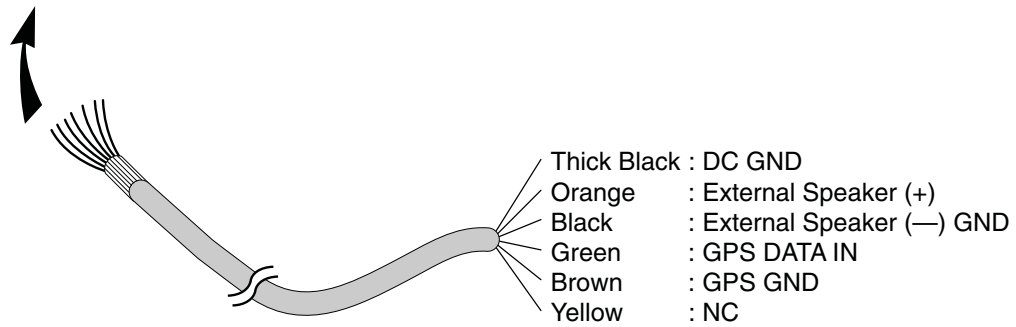

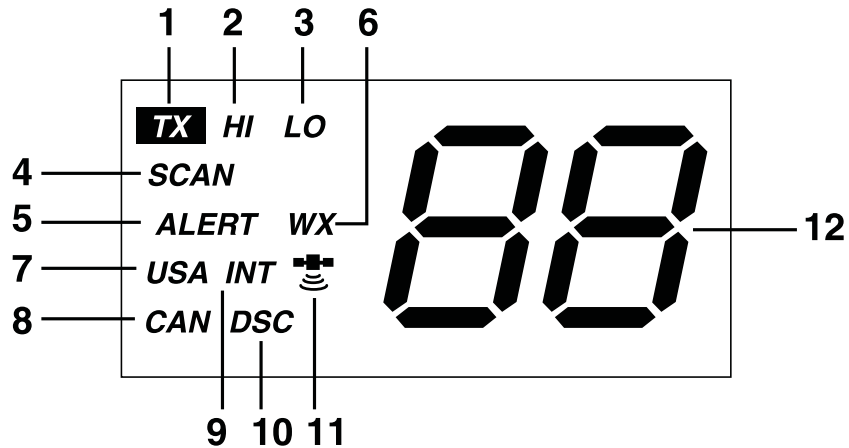

1. **TX** (Transmit) - Indicates transmitting.
2. **HI** (High) - Indicates transmit output is 25 Watts.
3. **LO** (Low) - Indicates transmit output is 1 Watt.
4. **SCAN** - Indicates Scan Mode has been activated.
5. **ALERT** - Indicates Weather Alert Mode has been activated.
6. **WX** - Indicate Weather Channel Mode has been activated.
7. **USA** - Indicates US Channel Mode.
8. **CAN** - Indicates Canada Channel Mode.
9. **INT** - Indicates International Channel Mode.
10. **DSC** - Indicators the radio is in the DSC mode.
11. **GPS Icon** (**GPS Icon**) - It appears while GPS module is receiving the data.
12. **Channel Display** - Indicates Channel Number in use.

Installation

Caution: The **SOLARA DSC** will only operate with a nominal **13.8 volt** negative ground battery system.

It is important to carefully determine the most suitable location for your radio on your vessel. Electrical, mechanical, and environmental considerations must all be taken into account. You should select the optimum relationship among these considerations.

Keep in mind the flexibility designed into the **SOLARA DSC** so that you can most conveniently use it. Features which should be considered are:

1. The universal mounting bracket may be installed on either the top or bottom of a shelf, on a bulkhead, or for overhead mounting.
2. The REMOTE speaker wires can be used with an auxiliary speaker.
3. Front fire internal speaker allows convenient in-dash mounting using the optional bracket.

Choosing a Location

Some important factors to consider in selecting the location for your **SOLARA DSC**.

1. Select a location that is free from spray and splash.
2. Keep the battery leads as short as possible. Direct connection to the battery is most desirable. If direct connection can not be made with the supplied power lead, any extension should be made with #10 AWG wire. Long extensions should use larger gauge wire.
3. Keep the antenna lead as short as possible. Long antenna leads can cause substantial loss of performance for both receiving and transmitting.
4. Locate your antenna as high as possible and clear from metal objects. The reliable range of coverage is a direct function of the antenna height.
5. Select a location that allows free air flow around the heat sink on the rear of the radio.
6. Select a location well away from the ship's compass. Auxiliary speakers also should be located away from the compass.

Engine Noise Suppression

Interference from the noise generated by the electrical systems of engines is sometimes a problem with radios. The **SOLARA DSC** has been designed to be essentially impervious to ignition noise and alternator noise. However, in some installations it may be necessary to take measures to further reduce the effect of noise interference. All DC battery wires, antenna lead, and accessory cables should be routed away from the engine and engine compartment, and from power cabling carrying high currents.

In severe cases of noise interference, it may be necessary to install a noise suppression kit. Contact your Uniden Dealer for more information.

Antenna Considerations

A variety of antennas are available from a number of quality suppliers. It is recommended you draw upon the advice of your Uniden dealer in determining a suitable antenna for your vessel and range requirements.

In general, communication range is increased by using a high-gain antenna placed as high as possible above the water line. Antennas should be located away from metal objects. Antennas should not have excessively long coaxial feed cables.

Antenna Selection and Installation

SOLARA DSC has been designed to accommodate all of the popular marine VHF antennas. However, the selection and the installation of the antenna is the responsibility of the user or installer.

The FCC has determined that excessive radiation poses a health risk to people near radio transmitting antennas. Therefore, the antenna used with this radio should be installed using the following guidelines to insure a suitable distance between the antenna and persons close by.

Small whip antennas (3 dB) or smaller should be installed keeping at least three feet separation distance between the radiating element and people.

Larger antennas (6 dB or 9 dB) should be installed keeping at least a six feet separation distance.

No person should touch the antenna or come into the separation distance when the radio is transmitting.

Installing the SOLARA DSC

After you have carefully considered the various factors affecting your choice of location, position the radio (with the bracket, microphone, power cord, antenna and any auxiliary cables installed) into the selected location to assure there is no interference with the surrounding items. Mark the location of the mounting bracket. Remove the bracket from the radio and use it as a template to mark the holes to be drilled for the mounting hardware. Drill the holes and mount the bracket with hardware compatible with the material of the mounting surface.

Note: *This HEXAGON HEAD BOLT is only for mounting the bracket with hardware. Do not use it for installing the radio in the mounting bracket.*

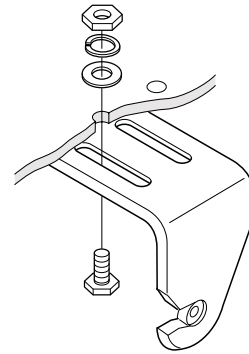

Connect the red wire of the supplied power cord to the positive (+) battery supply. Connect the black wire of the power cord to the negative (-) battery supply. The power cord is equipped with a fuse to protect the radio. Use only a six (6) ampere fast blow fuse for replacement. Connect the power cord to the keyed connector on the power "pigtail".

Connect the antenna and accessories. Install the radio in the mounting bracket and connect all cables and accessories to the appropriate jacks and connectors.

Note: *Do not use any other mounting knobs than the ones enclosed. Do not insert the knobs without attaching the bracket.*

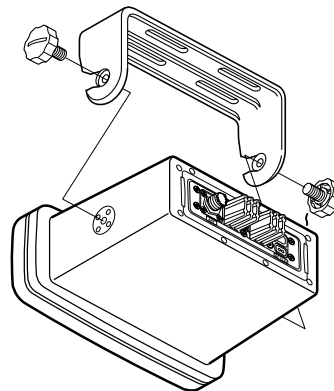

Operation

POWER On/Off

Turn the unit On by rotating the **PWR/VOL** control clockwise.
Adjust the volume to a comfortable level.

When you turn the unit On, you will hear a beep.

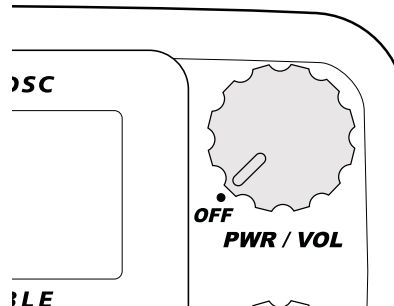

Note: When you turn On the radio for the first time after purchase, the channel 16 will appear on the LCD.

Last Channel Memory

The **SOLARA DSC** memorizes the last channel selected before you turn Off the radio. For example, if you turn Off the radio on CH 12, the CH 12 will be on that channel when turned back On.

Note: In order for the last channel to be memorized, you must have the radio on that channel for 3 seconds.

SQUELCH

Turn **SQUELCH** fully clockwise. This raises the “Squelch Gate” so high that only very strong signals can get through.

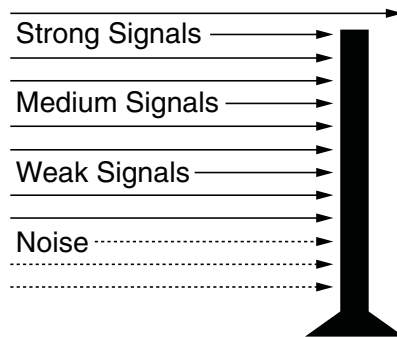
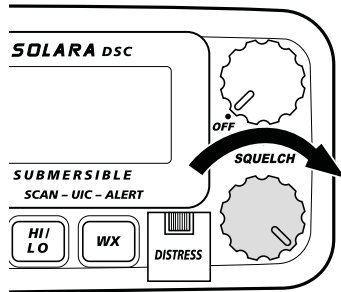

Turn **SQUELCH** fully counterclockwise until you hear a hiss. This lowers the “Squelch Gate” so that everything gets through - noise, weak signals, and strong signals.

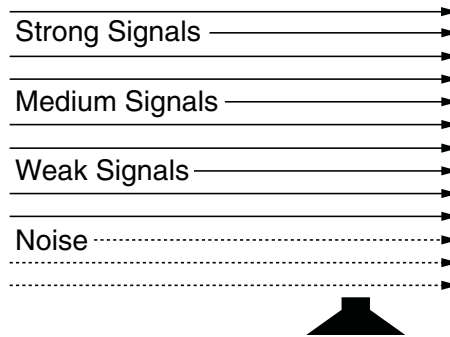
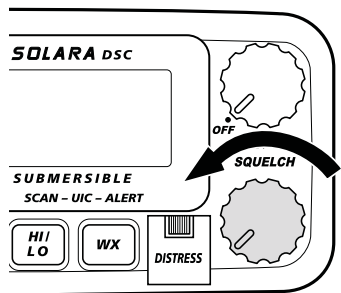

Turn **SQUELCH** back clockwise until the hiss stops. Now the “Squelch Gate” allows strong, medium, and weak signals through.

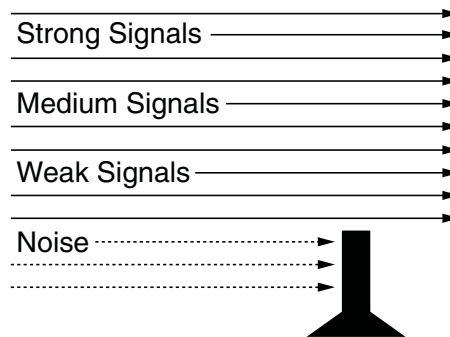
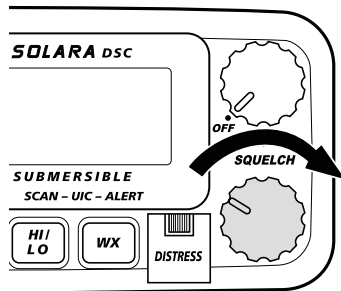

COAST GUARD CHANNEL 16/CHANNEL 9 COMMUNICATIONS

To access Coast Guard Channel 16 or Channel 9 communications, press **16/9**. You can access Coast Guard 16 CH instantly while tuned to another channel. Press **16/9** again for Channel 9 Calling communications. Press **16/9** a third time to return to the channel selected prior to accessing Coast Guard Channel 16/Channel 9 communications.

The display will indicate the selected channel.

To cancel Coast Guard Channel 16/Channel 9 communications:

- Press **16/9** until the previous channel setting appears.

--or--

- Press **WX/ALERT/UIC** or **CH ▲, ▼**.

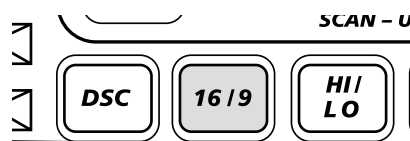

SELECTING A CHANNEL

To manually select a channel, press **CH ▲** or **▼**. Communication channels are located on channel 01-28 and 60-88. Weather channels are located on channels WX 0-9.

Note: *In the US, the Coast Guard may refer to Channels 21, 22, 23 etc. as 21 alpha, 22 alpha, etc. The SOLARA shows these channels in the USA mode as channel 21, 22, 23, etc.*

WEATHER CHANNELS

To select Weather Channels 0-9, press **WX/ALERT/UIC**. The radio will go to the last selected Weather Channel. Press **CH ▲** or **▼** to select a different Weather Channel. Most areas of the US are covered by Weather Channels 1,2, and 3.

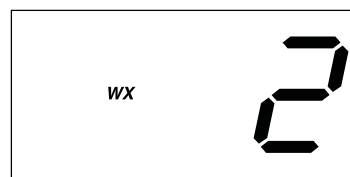

To exit from Weather Channel:

- Press **WX/ALERT/UIC**. The radio returns to the previous Marine channel.

All Channel Scan

To turn Scan On, press and hold **HI/LO/SCAN/UIC** for 2 seconds.

To turn Alert Scan On, press and hold **WX/ALERT/UIC** for 2 seconds. While all channels are scanned, WX CH is scanned every 7 seconds. **ALERT** appears on the LCD.

Weather Alert

The Weather Alert mode can be activated to alert you of dangerous weather. When Weather Alert is turned On, and a warning signal is received, an emergency siren will sound. When the signal stops, you will hear the active weather channel broadcast at the normal volume.

Your radio's Weather Alert feature lets it monitor the local weather channel for NOAA weather alert broadcasts, while allowing you to listen to other channels.

The **ALERT** indicates the Weather Alert mode is activated. To activate the Weather Alert mode:

1. Press and hold **WX/ALERT/UIC** for 2 seconds when WX ALERT is Off. The radio turns the WX ALERT On and the **ALERT** appears.

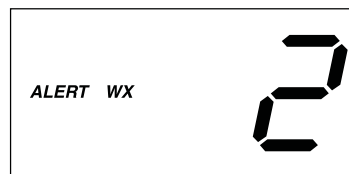

2. If the radio receives a 1050Hz tone, the **ALERT** and channel number will blink every other second and the alert tone will ring.

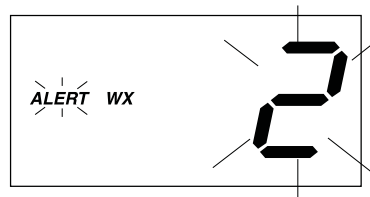

3. When a WX ALERT signal is received, all other functions are canceled and the radio remains on the selected weather channel.

When the radio is in All Channel Scan mode, scanning the weather channel every 7 seconds.

In order to stop the alert press any key. If you press any key once more, the **ALERT** disappears.

SETTING THE TRANSMIT (TX) POWER

The **SOLARA DSC** transmits on fifty-six marine frequencies and receives on eighty-one marine frequencies. Channel 70 of the USA, International, and Canadian frequencies, and channel 15 of the USA frequencies, and WX CH – are for receiving only. The radio transmits on channel 70 when sending DSC information. Your radio will not transmit on these channels. For your reference, a listing of all the available marine channels are located on pages 22 - 24.

Caution: *It is important to remember to use the LO position in port or for short range communications.*

1. When you turn the radio On for the first time, the unit is automatically set to transmit at 25 watts (HI).

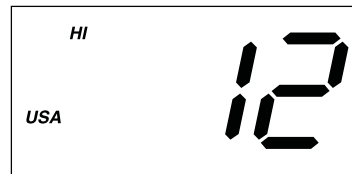

2. Press **HI/LO/SCAN/UIC** to change the transmitter output to 1 watt (LO).

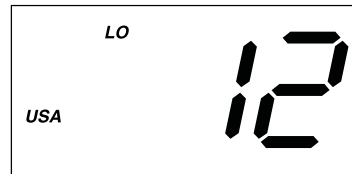

3. Press **HI/LO/SCAN/UIC** again to change back to 25 watts (HI).

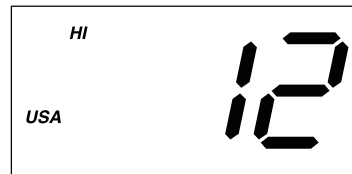

Note: *A short tone sounds everytime you press the **HI/LO/SCAN/UIC**. CH13 is 1 watt (LO) channel. When the channel is LO power channel, you can transmit at 25 watts (HI) by pressing **HI/LO/SCAN/UIC** during the call. LO power channels are USA Channels 13, 67, 75, 76; Canadian Channels 13, 15, 17, 20; . Use low transmit power in harbors or when close to the receiving station. You can not change the transmit power setting on channels which are receive-only channels: all weather channels; USA Channels 15, 70; Canadian Channel 70; International Channel 70.*

RECOMMENDED EMERGENCY BROADCAST INSTRUCTIONS

1. Make sure your radio is on.
2. Tune to channel 16.
3. Press the microphone button and, speaking slowly – clearly – calmly, say:
 - a. "MAYDAY – MAYDAY – MAYDAY" for situations involving Immediate Danger to Life and Property: or
 - b. "PAN – PAN – PAN" for urgent situations where there is No Immediate Danger to Life or Property.
4. Say: "THIS IS (INSERT VESSEL'S NAME), (INSERT VESSEL'S NAME), (INSERT VESSEL'S NAME), (INSERT VESSEL'S CALL SIGN), OVER".
5. Release the microphone button briefly and listen for acknowledgement. If no one answers, repeat steps 3 & 4.
6. If there is no acknowledgement, or if the Coast Guard or another vessel responds, say: "MAYDAY" or "PAN" (INSERT VESSEL'S NAME)".
7. DESCRIBE YOUR POSITION using latitude and Longitude coordinates, LORAN coordinates, or range and bearing from a known point.
8. STATE THE NATURE OF THE DISTRESS.
9. GIVE NUMBER OF PERSONS ABOARD AND THE NATURE OF ANY INJURIES.
10. ESTIMATE THE PRESENT SEA-WORTHINESS OF YOUR VESSEL.
11. BRIEFLY DESCRIBE YOUR VESSEL: (INSERT LENGTH, COLOR, HULL TYPE, TRIM, MASTS, POWER, AND ANY ADDITIONAL DISTINGUISHING FEATURES).
12. Say: "I WILL BE LISTENING ON CHANNEL 16/21/82".
13. End message by saying: "THIS IS (INSERT VESSEL'S NAME & CALL SIGN)".
14. If your situation permits, standby the radio to await further communications with the Coast Guard or another vessel. If no answer, repeat, then try another channel.

DISTRESS

Note: You must set the user MMSI in order to send a Distress call. Please see page 20 to set the MMSI.

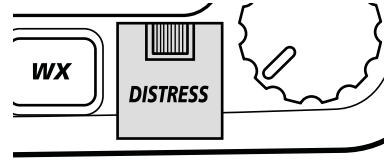

This feature will allow you to transmit a Distress call.

1. In order to transmit a Distress call, press and hold **DISTRESS** for 5 seconds. When **DSC** appears on the display, press **SELECT** to send the Distress call.

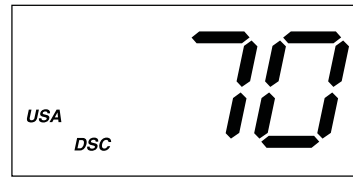

2. The Distress call is transmitted and it waits for about 210 - 270 seconds for an acknowledgement from the Coast Guard before the Distress call is resent. After the Distress call has been sent, the Distress alert will sound every other second. The radio will automatically change to channel 16, and it also watches channel 70 in the background until an acknowledgement signal is received from the Coast Guard shore station.

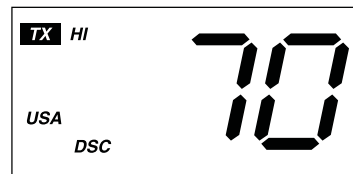
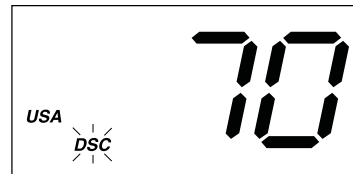

To cancel the Distress call, press **16/9**.

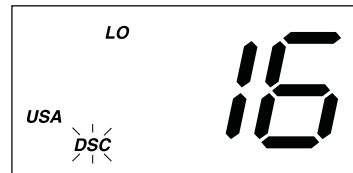

3. If an acknowledgment is not received, the Distress call is repeated until an acknowledgment is received from the Coast Guard shore station.

DIGITAL SELECTIVE CALLING (DSC)

Digital Selective Calling is the latest in Marine Radio technology. DSC is a process of establishing a radio call and has been chosen by the International Maritime Organization (IMO) as an international standard for establishing VHF, MF and HF radio calls. Digital Selective Calling has also been selected as part of the Global Maritime Distress and Safety System (GMDSS).

This service will let you instantly send a Distress call with GPS position (when optional GPS receiver is connected to the **SOLARA DSC**) to the US Coast Guard and other vessels within range of the transmission. DSC will also let you initiate or receive distress, urgency, safety, position information and routine calls to or from another vessel outfitted with a DSC transceiver.

See the directory section for instructions on how to setup the directory of names.

INDIVIDUAL

This feature allows the user to contact another boat and to automatically switch the receiving DSC radio to desired channel.

1. Press **DSC**.

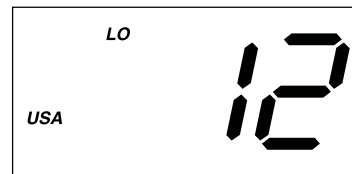

2. **12** appears.
Press **SELECT**.

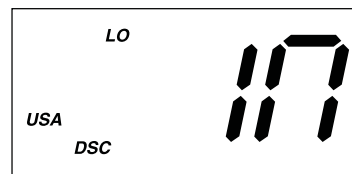

3. Select the individual you want to contact using **CH ▲** and **▼** to select the number from 0 to 9. The number will be entered when **SELECT** is pressed, and blinking digit moves to the next digit. When you enter the last digit, the confirmation screen appears. Press **SELECT** to transmit the individual DSC signal.

ALL SHIPS

This radio has the ability to send 3 types of all ships calls. The following are examples of what these types of calls would be used for:

Urgency - This call is for a vessel not yet in Distress, but may have a serious problem.

Safety - This call is used for a reason like debris in the Water.

Routine - This call is used for normal calls.

1. Press **DSC**.

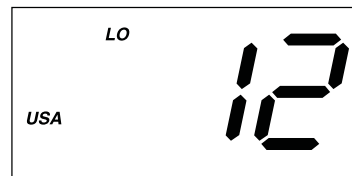

2. Press **CH ▼** or **CH ▲** to select **AL** (ALL SHIPS).

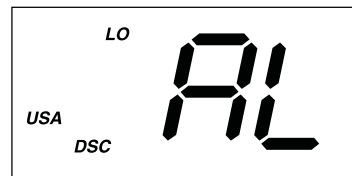

3. Press **SELECT**. **Ur** (URGENCY) appears.

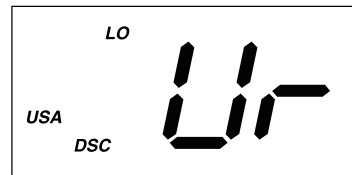

4. Select the category of your call using **CH** ▲ and ▼ URGENCY *Ur*, ROUTINE *r0*, SAFETY *SA*.



Note: ROUTINE calls tune to the previously selected channel.

5. Press **SELECT** to transmit the ALL SHIPS DSC signal.
When sending either an URGENCY or SAFETY message, all radios will automatically move to channel 70 until all of the data is received.

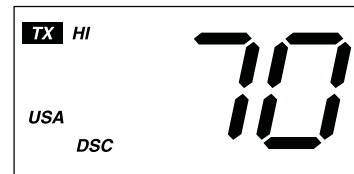

6. After selecting URGENCY or SAFETY ALL SHIPS call is transmitted, the radio will switch to Channel 16. You should wait a few minutes before transmitting the ALL SHIPS call information.

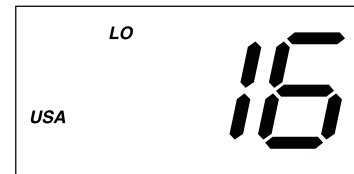

USER MMSI

Federal MMSI's are issued by the National Telecommunications and Information Administration. Non-Federal MMSI's are issued by the Federal Communications Commission (FCC). You will need to obtain a nine digit MMSI number and program it into the **SOLARA DSC**. The information obtained from the application is useful to the U.S. Coast Guard to help in search and rescue operations. To obtain an MMSI number, contact your authorized Uniden dealer or visit one of the following websites: <http://wireless.fcc.gov/marine/fctsht14.html>, www.boatus.com/mmsi/, or www.seatow.com/boatingsafety/mmsiinfo.htm

This portion of the SETUP menu will allow you to program an MMSI, (Maritime Mobile Service Identity) for sending and receiving DSC calls.

To set USER MMSI code

1. Press and hold **DSC** when you turn the radio ON.

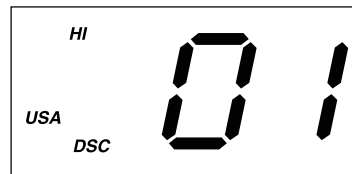

Note: MMSI can be checked when **16/9** is pressed.

2. Press **DSC** to enter the registration mode. Press **▲** or **▼** button to select number from 0 to 9. The number will be entered when **SELECT** is pressed, and the blinking digit moves to the next digit.

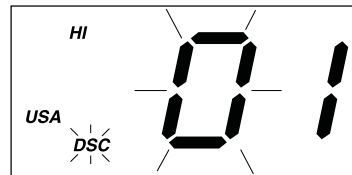

3. When you enter the last digit, the confirmation screen appears.

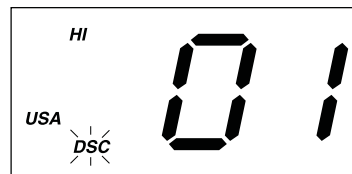

4. Press **SELECT** and turn the radio off to set the user MMSI code.

Note: You can only program your radio twice with an MMSI number. After that, send your radio to Uniden for factory service.

Note: **SOLARA DSC** will reply to the "Position Request" without any notice.

NMEA Technical Setup

SOLARA DSC NMEA0183 GPS Input Connection Specification

This section is useful when attaching an external GPS to the **SOLARA DSC** radio. Many GPS units have a setup menu to be able to configure the NMEA0183 serial data output. This output can be used to supply information to other devices on the vessel, such as the **SOLARA DSC** VHF radio, auto pilots, chart plotters, etc.

To setup the GPS to be used with the **SOLARA DSC** radio, the following items need to be considered for proper operation:

1. Baud Rate – Set the Baud rate to 4800.
2. Data Bits – Set the Data Bits to 8.
3. Parity – Set the Parity to None.
4. Stop Bits – Set the Stop Bits to 1.
5. RMC, GLL, GGA, GNS, and ZDA Command – These commands are used by the **SOLARA DSC** and includes the UTC Time, Latitude, and Longitude.

The data amplitude : Over 3.0V

Drive capability : Over 10mA

Optional Accessories

- Flush mounting bracket for “in dash” installation.
(White = FMB322W, Black = FMB322B)

Contact your Uniden Dealer for information.

VHF FM Marine Radio Telephone Channel and Functions (USA Channels)

CHANNEL DESIG	FREQUENCY (MHz)		TYPE OF TRAFFIC	SHIP TO SHIP	SHIP TO SHORE
	TRANSMIT	RECEIVE			
WX0	—	163.275	NOAA Weather	RX Only	RX Only
WX1	—	162.550	NOAA Weather	RX Only	RX Only
WX2	—	162.400	NOAA Weather	RX Only	RX Only
WX3	—	162.475	NOAA Weather	RX Only	RX Only
WX4	—	162.425	NOAA Weather	RX Only	RX Only
WX5	—	162.450	NOAA Weather	RX Only	RX Only
WX6	—	162.500	NOAA Weather	RX Only	RX Only
WX7	—	162.525	NOAA Weather	RX Only	RX Only
WX8	—	161.650	Can. Weather	RX Only	RX Only
WX9	—	161.775	Can. Weather	RX Only	RX Only
01	156.050	156.050	VTS	Yes	Yes
02					
03	156.150	156.150	Port Ops	Yes	Yes
04					
05	156.250	156.250	VTS	Yes	Yes
06	156.300	156.300	Safety	Yes	No
07	156.350	156.350	Com'l	Yes	Yes
08	156.400	156.400	Com'l	Yes	No
09	156.450	156.450	Com'l & Non Com'l	Yes	Yes
10	156.500	156.500	Com'l	Yes	Yes
11	156.550	156.550	Com'l	Yes	Yes
12	156.600	156.600	Port Ops	Yes	Yes
13	156.650	156.650	Navigational, TX 1W only	Yes	Yes
14	156.700	156.700	Port Ops	Yes	Yes
15	—	156.750	Environmental	RX Only	RX Only
16	156.800	156.800	Safety Calling	Yes	Yes
17	156.850	156.850	State Control	Yes	Yes
18	156.900	156.900	Com'l	Yes	Yes
19	156.950	156.950	Com'l	Yes	Yes
20	157.000	157.000	Port Ops, RX Duplex	Yes	Yes
21	157.050	157.050	Coast Guard	Yes	Yes
22	157.100	157.100	Coast Guard	Yes	Yes
23	157.150	157.150	Coast Guard	Yes	Yes
24	157.200	161.800	Public Corresp,Duplex	No	Yes
25	157.250	161.850	Public Corresp,Duplex	No	Yes
26	157.300	161.900	Public Corresp,Duplex	No	Yes
27	157.350	161.950	Public Corresp,Duplex	No	Yes
28	157.400	162.000	Public Corresp,Duplex	No	Yes
60					
61	156.075	156.075			
62					
63	156.175	156.175			
64	156.225	156.225			
65	156.275	156.275	Port Ops	Yes	Yes
66	156.325	156.325	Port Ops	Yes	Yes
67	156.375	156.375	Com'l, TX 1W only	Yes	No
68	156.425	156.425	Non Com'l	Yes	Yes
69	156.475	156.475	Non Com'l	Yes	Yes
70	—	156.525		RX Only	RX Only
71	156.575	156.575	Non Com'l	Yes	Yes
72	156.625	156.625	Non Com'l	Yes	No
73	156.675	156.675	Port Ops	Yes	Yes
74	156.725	156.725	Port Ops	Yes	Yes
75	156.775	156.775			
76	156.825	156.825			
77	156.875	156.875	Port Ops	Yes	No
78	156.925	156.925	Non Com'l	Yes	Yes
79	156.975	156.975	Com'l	Yes	Yes
80	157.025	157.025	Com'l	Yes	Yes
81	157.075	157.075	Coast Guard	Yes	Yes
82	157.125	157.125	US Govt Only	Yes	Yes
83	157.175	157.175	Coast Guard	Yes	Yes
84	157.225	161.825	Public Corresp,Duplex	No	Yes
85	157.275	161.875	Public Corresp,Duplex	No	Yes
86	157.325	161.925	Public Corresp,Duplex	No	Yes
87	157.375	161.975	Public Corresp,Duplex	No	Yes
88	157.425	157.425	Com'l	Yes	No

VHF FM Marine Radio Telephone Channel and Functions (International Channels)

CHANNEL DESIG	FREQUENCY (MHz)		TYPE OF TRAFFIC	SHIP TO SHIP	SHIP TO SHORE
	TRANSMIT	RECEIVE			
WX0	—	163.275	NOAA Weather	RX Only	RX Only
WX1	—	162.550	NOAA Weather	RX Only	RX Only
WX2	—	162.400	NOAA Weather	RX Only	RX Only
WX3	—	162.475	NOAA Weather	RX Only	RX Only
WX4	—	162.425	NOAA Weather	RX Only	RX Only
WX5	—	162.450	NOAA Weather	RX Only	RX Only
WX6	—	162.500	NOAA Weather	RX Only	RX Only
WX7	—	162.525	NOAA Weather	RX Only	RX Only
WX8	—	161.650	Can. Weather	RX Only	RX Only
WX9	—	161.775	Can. Weather	RX Only	RX Only
01	156.050	160.650	VTS,Duplex	Yes	Yes
02	156.100	160.700	Port Ops,Duplex	Yes	Yes
03	156.150	160.750	Port Ops,Duplex	Yes	Yes
04	156.200	160.800	Port Ops,Duplex	Yes	Yes
05	156.250	160.850	VTS,Duplex	Yes	Yes
06	156.300	156.300	Safety	Yes	No
07	156.350	160.950	Com',Duplex	Yes	Yes
08	156.400	156.400	Com'l	Yes	No
09	156.450	156.450	Com'l & Non Com'l	Yes	Yes
10	156.500	156.500	Com'l	Yes	Yes
11	156.550	156.550	Com'l	Yes	Yes
12	156.600	156.600	Port Ops	Yes	Yes
13	156.650	156.650	Navigational	Yes	Yes
14	156.700	156.700	Port Ops	Yes	Yes
15	156.750	156.750	Environmental	Yes	Yes
16	156.800	156.800	Safety Calling	Yes	Yes
17	156.850	156.850	State Control	Yes	Yes
18	156.900	161.500	Com'l,Duplex	Yes	Yes
19	156.950	161.550	Com'l,Duplex	Yes	Yes
20	157.000	161.600	Port Ops,Duplex	Yes	Yes
21	157.050	161.650	Coast Guard,Duplex	Yes	Yes
22	157.100	161.700	Coast Guard,Duplex	Yes	Yes
23	157.150	161.750	Coast Guard,Duplex	Yes	Yes
24	157.200	161.800	Public Corresp,Duplex	No	Yes
25	157.250	161.850	Public Corresp,Duplex	No	Yes
26	157.300	161.900	Public Corresp,Duplex	No	Yes
27	157.350	161.950	Public Corresp,Duplex	No	Yes
28	157.400	162.000	Public Corresp,Duplex	No	Yes
60	156.025	160.625	Duplex		
61	156.075	160.675	Duplex		
62	156.125	160.725	Duplex		
63	156.175	160.775	Duplex		
64	156.225	160.825	Duplex		
65	156.275	160.875	Port Ops,Duplex	Yes	
66	156.325	160.925	Port Ops,Duplex	Yes	Yes
67	156.375	156.375	Com'l	Yes	No
68	156.425	156.425	Non Com'l	Yes	Yes
69	156.475	156.475	Non Com'l	Yes	Yes
70	—	156.525		RX Only	RX Only
71	156.575	156.575	Non Com'l	Yes	Yes
72	156.625	156.625	Non Com'l	Yes	No
73	156.675	156.675	Port Ops	Yes	Yes
74	156.725	156.725	Port Ops	Yes	Yes
77	156.875	156.875	Port Ops	Yes	No
78	156.925	161.525	Non Com'l,Duplex	Yes	Yes
79	156.975	161.575	Com'l,Duplex	Yes	Yes
80	157.025	161.625	Com'l,Duplex	Yes	Yes
81	157.075	161.675	Coast Guard,Duplex	Yes	Yes
82	157.125	161.725	US Govt Only,Duplex	Yes	Yes
83	157.175	161.775	Coast Guard,Duplex	Yes	Yes
84	157.225	161.825	Public Corresp,Duplex	No	Yes
85	157.275	161.875	Public Corresp,Duplex	No	Yes
86	157.325	161.925	Public Corresp,Duplex	No	Yes
87	157.375	161.975	Public Corresp,Duplex	No	Yes
88	157.425	162.025	Com'l,Duplex	Yes	No

VHF FM Marine Radio Telephone Channel and Functions (Canadian Channels)

CHANNEL DESIG	FREQUENCY (MHz)		TYPE OF TRAFFIC	SHIP TO SHIP	SHIP TO SHORE
	TRANSMIT	RECEIVE			
WX0	—	163.275	NOAA Weather	RX Only	RX Only
WX1	—	162.550	NOAA Weather	RX Only	RX Only
WX2	—	162.400	NOAA Weather	RX Only	RX Only
WX3	—	162.475	NOAA Weather	RX Only	RX Only
WX4	—	162.425	NOAA Weather	RX Only	RX Only
WX5	—	162.450	NOAA Weather	RX Only	RX Only
WX6	—	162.500	NOAA Weather	RX Only	RX Only
WX7	—	162.525	NOAA Weather	RX Only	RX Only
WX8	—	161.650	Can. Weather	RX Only	RX Only
WX9	—	161.775	Can. Weather	RX Only	RX Only
01	156.050	160.650	Duplex	Yes	Yes
02	156.100	160.700	Duplex	Yes	Yes
03	156.150	160.750	Duplex	Yes	Yes
04	156.200	156.200		Yes	Yes
05	156.250	156.250		Yes	Yes
06	156.300	156.300		Yes	No
07	156.350	156.350		Yes	Yes
08	156.400	156.400		Yes	No
09	156.450	156.450		Yes	Yes
10	156.500	156.500		Yes	Yes
11	156.550	156.550		Yes	Yes
12	156.600	156.600		Yes	Yes
13	156.650	156.650	1W	Yes	Yes
14	156.700	156.700		Yes	Yes
15	156.750	156.750	1W	Yes	Yes
16	156.800	156.800		Yes	Yes
17	156.850	156.850	1W	Yes	Yes
18	156.900	156.900		Yes	Yes
19	156.950	156.950		Yes	Yes
20	157.000	161.600	Duplex, 1W	Yes	Yes
21	157.050	157.050		Yes	Yes
22	157.100	157.100		Yes	Yes
23	157.150	161.750	Duplex	Yes	Yes
24	157.200	161.800	Duplex	No	Yes
25	157.250	161.850	Duplex	No	Yes
26	157.300	161.900	Duplex	No	Yes
27	157.350	161.950	Duplex	No	Yes
28	157.400	162.000	Duplex	No	Yes
60	156.025	160.625	Duplex		
61	156.075	156.075			
62	156.125	156.125			
63	—	—			
64	156.225	156.225			
65	156.275	156.275		Yes	Yes
66	156.325	156.325		Yes	Yes
67	156.375	156.375		Yes	No
68	156.425	156.425		Yes	Yes
69	156.475	156.475		Yes	Yes
70	—	156.525		RX Only	RX Only
71	156.575	156.575		Yes	Yes
72	156.625	156.625		Yes	No
73	156.675	156.675		Yes	Yes
74	156.725	156.725		Yes	Yes
77	156.875	156.875		Yes	No
78	156.925	156.925		Yes	Yes
79	156.975	156.975		Yes	Yes
80	157.025	157.025		Yes	Yes
81	157.075	157.075		Yes	Yes
82	157.125	157.125		Yes	Yes
83	157.175	157.175		Yes	Yes
84	157.225	161.825	Duplex	No	Yes
85	157.275	161.875	Duplex	No	Yes
86	157.325	161.925	Duplex	No	Yes
87	157.375	161.975	Duplex	No	Yes
88	157.425	162.025	Duplex	Yes	No

Specification

General

Channels	: All International, U.S.A. and Canadian channels, plus 10 Weather channels
Controls	: On-Off/Volume, Squelch
Status Indicators	: TX (Transmit), HI (High), LO (Low), SCAN, ALERT, WX, USA, INT, CAN, DSC,  (GPS), and Channel Display
Channel Display	: LCD with Orange backlight
Buttons	: 16/9, DISTRESS, DSC, SELECT, HI/LO/SCAN/UIC, WX/ALERT/UIC, CH▲ or ▼
Connectors	: Antenna, ACC, and DC cord
Size	: H63 mm x W160 mm x L168 mm (W/O Heat Sink) H2.52 inches x W6.4 inches x L6.72 inches
Weight	: 920 g / 2.03 lbs / 32.4 oz
Supply Voltage	: 13.8V DC negative ground
Standard Accessories	: Mounting bracket and hardware, microphone hanger, spare fuse
Antenna Impedance	: 50 Ω nominal
Microphone	: Rugged 2 k Ω condenser mic element with coiled cord
Speaker	: 1.82 inch, Mylar Cone 8 Ω
Operating Temperature Range	: -20 °C to + 50 °C (-4 °F to +122 °F)
Shock and Vibration	: Meets or exceeds EIA standards, RS152B and RS204C
FCC Approvals	: Type accepted under part 80 of the Rules; meets Great Lakes Agreement and party boat requirements

Transmitter

Power Output	: 1 watt or 25 watt (switch selectable)
Power Requirement	: Not rated on LO, 25 watts output: 5.3A@13.8V DC
Modulation	: FM ± 5 kHz deviation (FCC designator F3E)
Hum and Noise Signal-to-Noise	: 45 dB@1 kHz with 3 kHz deviation with 1000 Hz modulating frequency (nominal)
Audio Distortion	: Less than 8% with 3 kHz deviation with 1000 Hz modulating frequency
Spurious Suppression	: -35 dBm @ Hi, -23 dBm @ Lo
Output Power Stabilization	: Built-in automatic level control (ALC)
Frequency Range	: 156 to 157 MHz
Frequency Stability	: ± 10 ppm @ -20°C to + 50°C

Receiver

Frequency Range	: 156 to 163 MHz
Sensitivity	: 0.25 μ V for 12 dB SINAD
Circuit	: Dual Conversion Super Heterodyne PLL
Squelch Sensitivity	: 0.2 μ V Threshold
Spurious Response	: 85 dB
Adjacent Channel Selectivity	: 67 dB @ ± 25 kHz
Audio Output Power	: 2.8 watts (10% Distortion)
Power Requirement	: 270 mA @ 13.8V DC squelched, 0.6A @ 13.8V DC at maximum audio output
IF Frequencies	: 1st 21.4 MHz, 2nd 455 kHz

Troubleshooting

If the **SOLARA DSC** does not perform to your expectations, try the suggestions listed below. If you cannot get satisfactory results, call the Uniden Technical Support at (800) 586-0409, 8:00 a.m. to 5:00 p.m., Central Standard Time, Monday through Friday.

SYMPTOM	CAUSE	REMEDY
Won't power On.	No or low voltage.	Check for proper voltage getting to the set.
When the PTT is pressed - Tx comes on and another radio can hear a "click" but no audio is heard.	Bad mic element.	Send in for repair.
While scanning, the radio stops on a particular channel all of the time.	A source of noise is nearby.	Eliminate the source of the noise or briefly press the channel ▲ or channel ▼ key.
There is noise on the receiver that the squelch will not eliminate.	An external noise is being generated by some device.	Either turn off the offending device or contact that Mfg. Regarding FCC part 15 "unintentional radiator".

Care and Maintenance

Your **SOLARA DSC** is a precision of electronic equipment and you should treat it accordingly. Due to the rugged design, very little maintenance is required. However, a few precautions should be observed:

- If the antenna has been damaged, you should not transmit except in the case of an emergency. A defective antenna may cause damage to your radio.
- You are responsible for continued FCC technical compliance of your radio.
- You are urged to arrange for periodic performance checks with your Uniden Marine dealer.

Note :

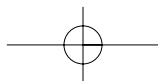
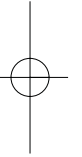
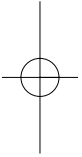

Three Years Limited Warranty

WARRANTOR: UNIDEN AMERICA CORPORATION (“Uniden”)

ELEMENTS OF WARRANTY: Uniden warrants, for three years, to the original retail owner, this Uniden Product to be free from defects in materials and craftsmanship with only the limitations or exclusions set out below.

WARRANTY DURATION: This warranty to the original user shall terminate and be of no further effect 36 months after the date of original retail sale. The warranty is invalid if the Product is (A) damaged or not maintained as reasonable or necessary, (B) modified, altered, or used as part of any conversion kits, subassemblies, or any configurations not sold by Uniden, (C) improperly installed, (D) serviced or repaired by someone other than an authorized Uniden service center for a defect or malfunction covered by this warranty, (E) used in any conjunction with equipment or parts or as part of any system not manufactured by Uniden, or (F) installed or programmed by anyone other than as detailed by the Operating Guide for this product.

STATEMENT OF REMEDY: In the event that the product does not conform to this warranty at any time while this warranty is in effect, warrantor will repair the defect and return it to you without charge for parts, service, or any other cost (except shipping and handling) incurred by warrantor or its representatives in connection with the performance of this warranty. THE LIMITED WARRANTY SET FORTH ABOVE IS THE SOLE AND ENTIRE WARRANTY PERTAINING TO THE PRODUCT AND IS IN LIEU OF AND EXCLUDES ALL OTHER WARRANTIES OF ANY NATURE WHATSOEVER, WHETHER EXPRESS, IMPLIED OR ARISING BY OPERATION OF LAW, INCLUDING, BUT NOT LIMITED TO ANY IMPLIED WARRANTIES OF MERCHANTABILITY OR FITNESS FOR A PARTICULAR PURPOSE. THIS WARRANTY DOES NOT COVER OR PROVIDE FOR THE REIMBURSEMENT OR PAYMENT OF INCIDENTAL OR CONSEQUENTIAL DAMAGES. Some states do not allow this exclusion or limitation of incidental or consequential damages so the above limitation or exclusion may not apply to you.

LEGAL REMEDIES: This warranty gives you specific legal rights, and you may also have other rights which vary from state to state. This warranty is void outside the United States of America.

PROCEDURE FOR OBTAINING PERFORMANCE OF WARRANTY: If, after following the instructions in this Operating Guide you are certain that the Product is defective, pack the Product carefully (preferably in its original packaging). Include evidence of original purchase and a note describing the defect that has caused you to return it. The Product should be shipped freight prepaid, by traceable means, or delivered, to warrantor at:

**Uniden America Corporation
Parts and Service Division
4700 Amon Carter Blvd.
Ft. Worth, TX 76155
(800) 235-3874, 8 AM to 5 PM Central,
Monday through Friday**

At Uniden, we care about you!

If you need assistance, please **DO NOT** return this product to your place of purchase. Our customer care specialists are available to help you!

Questions? Difficulties with operation? Quickly find answers to your questions by:

1. First, carefully read your owners manual included with this product.
2. Visit our customer support website at: www.uniden.com
3. Missing parts or accessories? Call Parts & Service at 1-800-554-3988.
4. For any other issues, please call our customer care specialists at 1-800-586-0409.



Uniden Recycles for a
Cleaner Environment.

©2004 Uniden America Corporation Fort Worth, TX
Custom manufactured in China.

CHECK OUT THE
 **LATEST ACCESSORIES**
www.uniden.com