

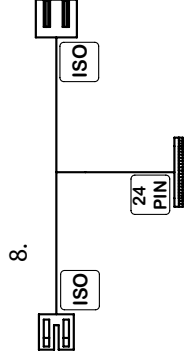

**QUICK START GUIDE**  
**GUIDE DE MISE EN ROUTE RAPIDE**  
**GUIDA RAPIDA**  
**KURZANLEITUNG**  
**GUÍA DE INICIO RÁPIDO**

CONTENTS PAGE .....	2
WHAT'S BEEN INSTALLED .....	3
WELCOME TO io .....	4
GET CONNECTED .....	5
THE CONSOLE .....	6
GET DISCONNECTED .....	8
FREQUENTLY ASKED QUESTIONS .....	9
WARRANTY INFORMATION .....	10
WARRANTY .....	10
TRADEMARK .....	10
COPYRIGHT .....	10
MODIFICATIONS .....	10
<b>SAFETY INFORMATION .....</b>	<b>11</b>
DECLARATION OF CONFORMITY .....	11
FCC COMPLIANCE STATEMENT .....	11
BLUETOOTH .....	11
CORRECT DISPOSAL OF THIS PRODUCT .....	11
<b>PRODUCT REGISTRATION .....</b>	<b>52</b>

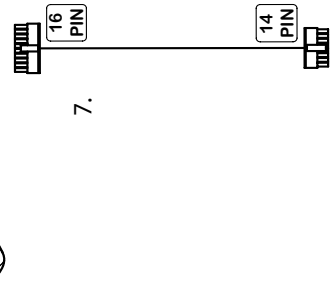
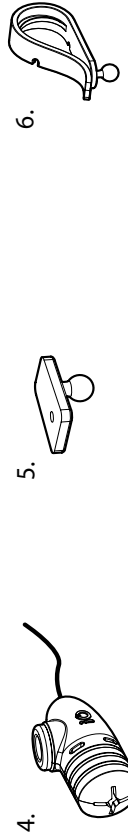
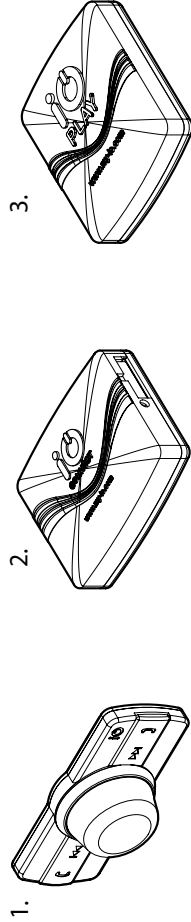

- |                              |  |
|------------------------------|--|
| 1. io PLAY Console.          | 5. io PLAY Microphone Small Clip.            |
| 2. io PLAY Amplifier.        | 6. io PLAY Microphone Large Clip.            |
| 3. io PLAY Bluetooth Module. | 7. io PLAY Bluetooth Harness.                |
| 4. io PLAY Microphone.       | 8. io PLAY ISO to 24-way microfit (T-piece). |

Thank you for purchasing an iO PLAY.

**iO CONNECT**

**iO PLAY**

**iO TALK1**

**iO TALK2**

**iO TALK3**

THE iO PRODUCT RANGE

**STEP 1**  
Turn on the ignition.

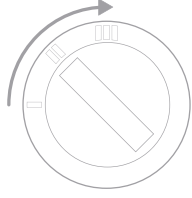

**STEP 2**  
Ensure your portable device is charged.

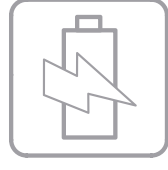

**STEP 3**  
Enable Bluetooth on your mobile phone or portable device.



**STEP 4**  
Search for "iO PLAY" from your device. Then select "iO PLAY".



**STEP 5**  
Pair to iO PLAY using Bluetooth Passcode: **0000**.

**STEP 6**  
Connect to iO PLAY. **NOTE: Ensure no other device is connected to iO PLAY when first connecting.**

- If connecting a Mobile phone (Non A2DP device) the Green and Red icons on the iO PLAY console will flash to confirm successful connection to iO PLAY (HFP Connection Status).
- If connecting with a A2DP device the white Skip buttons will flash to confirm successful connection.

**NOTE: Please refer to your portable device handbook when Enabling, Searching, Pairing and connecting Bluetooth as some manufacturers differ.**

**THE CONSOLE BUTTONS**

There are 3 buttons on the iO PLAY console.



**HANDS FREE (HFP) FUNCTIONS**

The console functions when connected with your mobile phone on the HFP (Hands Free Profile).

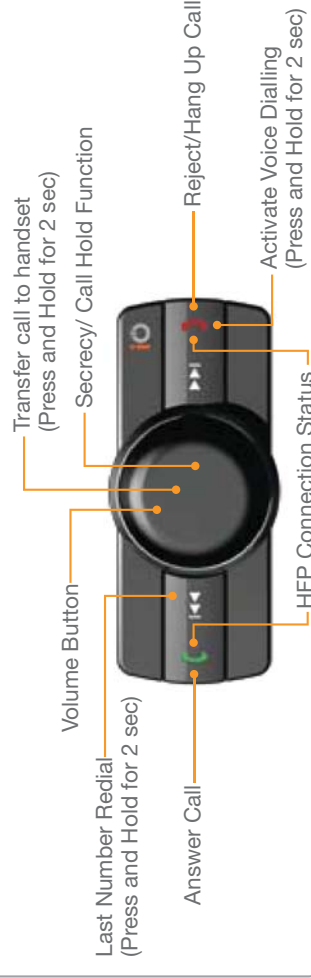

**THE BACK LIGHTING STATUS**

iO PLAY Status	LED Lighting Brightness	Icon example
HFP Unconnected (Hands Free Profile)	Very Dim	
HFP Connected (Hands Free Profile)	Dim	
HFP Active (Hands Free Profile)	Bright	
A2DP Unconnected (Stereo Bluetooth Profile)	Very Dim	
A2DP Connected (Stereo Bluetooth Profile)	Dim	
A2DP Active (Stereo Bluetooth Profile)	Bright	

LED will flash when the following event occurs:

- (1) Status changed from "Connected" to "Unconnected" in any profiles activated.
- (2) Status changed from "Unconnected" to "Connected" in any profiles activated.

**MUSIC STREAMING (A2DP) FUNCTIONS**

The console functions when connected with your mobile phone or Bluetooth enabled device on the Music Streaming profile (A2DP).

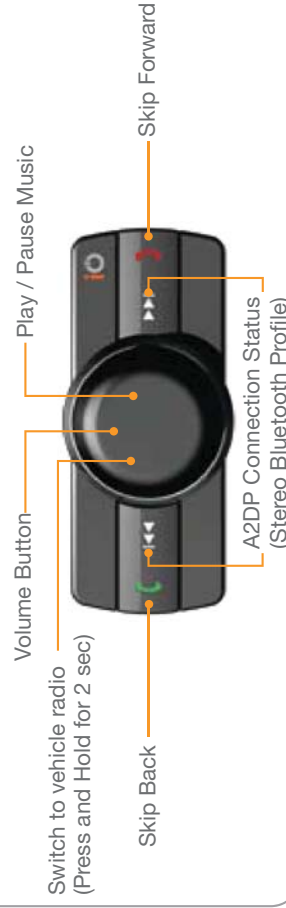

**NOTE:** To clear the Console memory press and hold down both the **Left and Right** buttons for 6 seconds until you hear 3 audio beeps.

**NOTE:** Please use your iO PLAY responsibly in your vehicle.

**STEP 1A - DISCONNECTING MOBILE PHONE**

On your mobile phone browse to the “**Connected Devices**” in the Bluetooth section. Highlight “iO PLAY” and select “**Disconnect**”.

Alternatively turn off Bluetooth on your mobile phone.

**NOTE:** Please refer to your mobile phone handbook when Enabling, Searching, Pairing and connecting Bluetooth as some manufacturers differ.

**STEP 1B - DISCONNECTING AN A2DP DEVICE**

To disconnect a device that is using an iO Bluetooth Adaptor press Stop and turn the portable device off.

If the iO Bluetooth Adaptor is being used remove the iO Bluetooth Adaptor and turn it off.



**NOTE:** Please refer to your portable device handbook when Enabling, Searching, Pairing and connecting Bluetooth as some manufacturers differ.

**NOTE:** Please refer to your iO Bluetooth Adaptor Manual for more comprehensive guidance.

**Q. MY DEVICE DOES NOT PLAY THROUGH MY CAR SPEAKERS WHEN I CONNECT AND PAIR TO iO PLAY?**

**Mobile Hands Free (HFP)**

- A. Ensure you have turned on your ignition in your vehicle.
- A. Ensure the iO PLAY console volume is turned up.
- A. Ensure your mobile phone is connected to iO PLAY (Red and Green icons are illuminated).
- A. Ensure your connected mobile phone is charged and switched on.

**Music Streaming (A2DP)**

- A. Ensure you have turned on your ignition in your vehicle.
- A. Ensure your device volume is turned up.
- A. Ensure the iO Bluetooth Adaptor (if used) is properly connected and functioning.
- A. Ensure your connected device is not stopped or paused.
- A. Ensure your connected device is charged and switched on.

**Q. IS MY DEVICE COMPATIBLE WITH iO PLAY?**

**Mobile Hands Free (HFP)**

- A. As long as your device is Bluetooth compatible it is compatible with iO PLAY Hands Free Profile (HFP).

**Music Streaming (A2DP)**

- A. If your device does not have A2DP Bluetooth profile your device will not experience the full music streaming potential of iO PLAY.



Part No:  
iO-BTA3-5



Part No:  
iO-BTAPOD

**NOTE:** If your device does not have Bluetooth, purchasing an iO Bluetooth Adaptor will able you to play Music via iO PLAY.

**Q. WHAT ELSE?**

- A. Visit [www.my-io.com/support](http://www.my-io.com/support) to view a more detailed user manual on using your iO PLAY, answers to some common problems you may experience and all relevant safety and compliance information. Also a full range of iO PLAY replacement accessories and details of stockists in your area can be found on the website.

## WARRANTY INFORMATION



### WARRANTY

Armour Automotive warrants this product to be free from defects in material and workmanship under normal use for a period of 12 months from the date of original purchase with receipt. Should service be necessary under this warranty for any reason due to manufacturing defect or malfunction during the warranty period, Armour Automotive will repair or replace (at its discretion) the defective merchandise with equivalent products. The warranty excludes damage or abuse caused by customer misuse. All warranties are to be handled by the original retailer where the goods were purchased.

This warranty is valid only for the original purchaser and is not extended to owners of the product subsequent to the original purchaser. Any applicable implied warranties are limited in duration to a period of the express warranty as provided herein beginning with the date of the original purchase at retail, and no warranties, whether express or implied, shall apply to this product thereafter.

Armour Automotive does not warrant failure of an iO product caused by incorrect installation by a non approved installation center.

### TRADEMARK

All rights reserved. The iO trademarks are the sole and exclusive property of Armour Automotive. Any other trademarks or names used in iO documentation are copyright protected and are the sole and exclusive property of their respective owners.

### COPYRIGHT

Copyright 2007; Armour Automotive. All rights reserved. The total or even partial reproduction, transmission or storage of this guide in any form or by any process whatsoever (electronic, mechanical, photocopy, recording or otherwise) is strictly prohibited without prior consent from Armour Automotive.

### MODIFICATIONS

The explanations and specifications in this guide are given for information purposes only and may be modified without prior notice. They are deemed to be correct at the time of going to press. The utmost care has been taken when writing this guide, as part of the aim to provide you with accurate information. However, Armour Automotive shall not be held responsible for any consequences arising from any errors or omissions in the guide. Armour Automotive reserves the right to amend or improve the product design or user guide without any restrictions and without any obligation to notify users.

As part of our ongoing concern to improve our products, the product that you have purchased may differ slightly from the model described in this guide. If so, a later version of this guide might be available in electronic format at [www.my-io.com](http://www.my-io.com).

## SAFETY INFORMATION



### DECLARATION OF CONFORMITY

We, Armour Automotive of Bordon, Hampshire, UK hereby declares that the device described in this guide is in compliance with the essential requirements and other relevant provisions of the European Directive 1999/5/EC (R&TTE). The declaration of conformity (DoC) concerned has been signed. Please call the Company if you require a copy of the original or refer to [www.my-io.com/conformity](http://www.my-io.com/conformity)



### FCC COMPLIANCE STATEMENT

This device complies with Part 15 of the FCC Rules. Operation is subject to the following two conditions: (1) this device may not cause harmful interference, and (2) this device must accept any interference received, including interference that may cause undesired operation.



Changes or modifications not expressly approved by the party responsible for compliance could void the user's authority to operate the equipment. The manufacturers are not responsible for any radio or TV interference caused by unauthorised modification or incorrect installation to this equipment.

FCC ID: VUHIOPLAY

### BLUETOOTH

The Bluetooth word mark and logos are owned by the Bluetooth® SIG, Inc. and any use of such marks by Armour Automotive and Armour Automotive's brand iO is under licence. Other trademarks and trade names are those of their respective owners.



BQ ID: B013456

### CORRECT DISPOSAL OF THIS PRODUCT (WASTE ELECTRICAL ELECTRONIC EQUIPMENT)

This marking shown on the product or its literature, indicates that it should not be disposed with other household wastes at the end of its working life. To prevent possible harm to the environment or human health from uncontrolled waste disposal, please separate this from other types of wastes and recycle it responsibly to promote the sustainable reuse of material resources. Household users should contact either the retailer where they purchased this product, or their local government office. Business users should contact their supplier and refer to the terms and conditions of the purchase contract. This product should not be mixed with other commercial wastes for disposals.



### E-MARK

E4 10R-021167